





Norlys jest skandynawską firmą z ponad pięćdziesięcioletnią tradycją w zakresie produkcji oświetlenia zewnętrznego. Oferujemy bardzo szeroki asortyment opraw zewnętrznych i dostarczamy najwyższą jakość naszym klientom na całym świecie.

Nie mamy tajemnic: Nasza jakość to wynik właściwego doboru materiałów produkcyjnych i profesjonalnego zarządzania procesem produkcyjnym. Wszystkie nasze produkty wytwarzane są na terenie Europy zgodnie z ISO 9001. W zakładzie produkcyjnym o powierzchni ponad 1500 m² wykorzystujemy innowacyjny park maszynowy, nasza odlewnia jest jedną z najnowocześniejszych tego typu w Europie. Stałe inwestycje na terenie zakładu pozwalają nam utrzymać procesy produkcyjne na najwyższym poziomie.

Kiedy nie możemy czegoś wykonać sami, starannie dobieramy naszych partnerów, jest to szczególnie ważne w przypadku stosowania najnowocześniejszej technologii LED. Zawsze współpracujemy z najlepszymi i sprawdzonymi dostawcami.

Design, szeroki asortyment, doskonała jakość to parametry które cechują nasze oprawy. Tam gdzie liczy się czas, wyjątkowo ważnym aspektem staje się termin realizacji zamówień. Dlatego posiadamy kilkanaście magazynów produktów gotowych do wysyłki, jeśli aktualnie określonego produktu nie ma na stanie, produkujemy go w ciągu kilku dni.

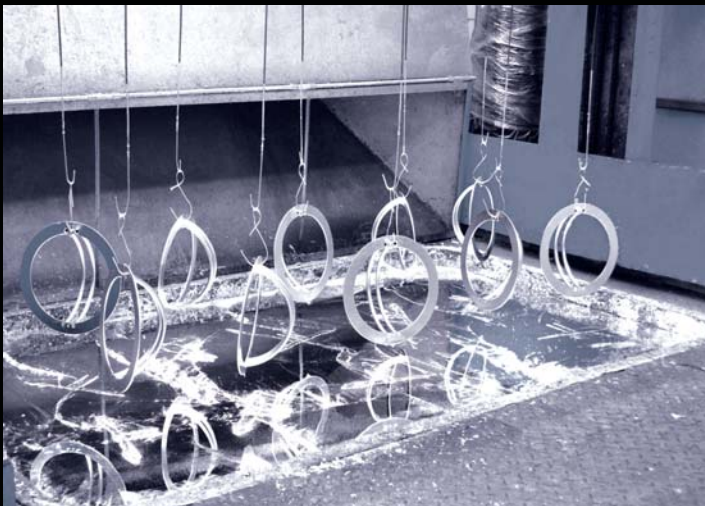
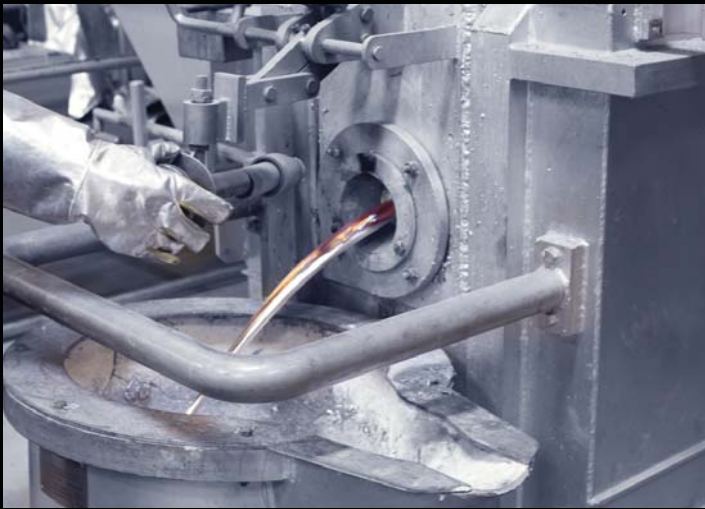

Zdjęcia zamieszczone w tym katalogu nie mogą być kopiowane bez zgody Norlys Sp. z o.o. Zastrzegamy sobie prawo do zmian charakterystyk modeli bez uprzedzenia i bez obowiązku powiadomienia, w zależności od własnych wymagań technicznych i/ lub w celu ulepszenia parametrów produktów.

INDEKS



ALTA
s. 42



ARVIKA
s. 17



ASKER
s. 26, 27



ARENDA
s. 21



BAZYLEA
s. 38, 39

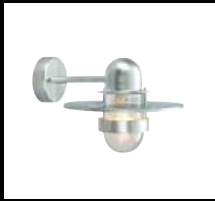

BERGEN RODZINA
s. 55



BERLIN
s. 48



BERNO
s. 38



BODEN
s. 30



BOLONIA RODZINA
s. 63



BORNHOLM
s. 34



BREMEN
s. 49



CHELSEA RODZINA
s. 56 - 58



COMO RODZINA
s. 70



CORTINA
s. 61



EGERSUND
s. 12, 13



FLORENCJA RODZINA
s. 71



GENEVA
s. 35



GENUA
s. 60



GENUA MINI
s. 60



GLASGOW
s. 61



GRIMSTAD
s. 24



HALDEN
s. 37



HALMSTAD RODZINA
s. 41



HELSINKI
s. 10, 11

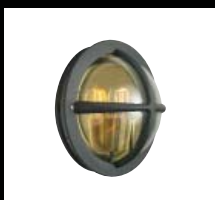

HAMBURG
s. 48



KARLSTAD
s. 54

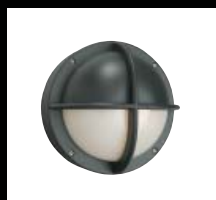

KIRUNA
s. 21



KOSTER RODZINA
s. 18, 19



LATINA
s. 61



LILLEHAMMER
s. 28, 29



LOFOTEN
s. 59



LONDON RODZINA
s. 64 - 67



LUND RODZINA
s. 52, 53



MODENA RODZINA
s. 68, 69

INDEKS



MOLDE
s. 40



NAMSOS RODZINA
s. 25



NARVIK
s. 16



NICEA
s. 6



NORDKAPP
s. 31



NORDLAND
s. 31



OSLO RODZINA
s. 50



PARIS
s. 51



RENA
s. 23



RIMINI/MILANO RODZINA
s. 62



ROMA
s. 60



RONDANE
s. 34



SANDE RODZINA
s. 22



SANDVIK RODZINA
s. 32, 33



DREWNO SKANDYNAWSKIE
s. 43

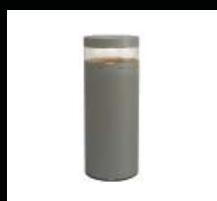

STAVANGER
s. 14, 15



STOCKHOLM RODZINA
s. 44 - 47



SUNNFJORD
s. 6, 7



TORINO
s. 60



VANSBRO
s. 55



VASA
s. 36



WENECJA
s. 60



VISBY
s. 8, 9



VOSS
s. 20



AKCESORIA/INFO
s. 72 - 74



NOWOŚCI
s. 75

NICEA

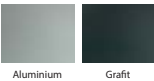

*Kolory niestandardowe Norlys za dopłatą

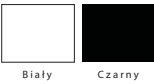

SUNNFJORD

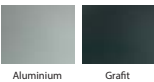

*Kolory niestandardowe Norlys za dopłatą

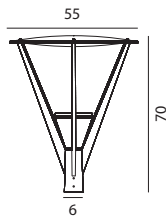

NICEA
IP65, Klasa I
Do słupa o średnicy zewnętrznej $\varnothing 60$ mm na szczycie

Akcesoria
Art. 3005, 3006, 3007: Możliwość dokupienia słupa: wraz z redukcją. (Strona 73)
Art. 154: Konsola z ramieniem od Nicea. (Strona 72)

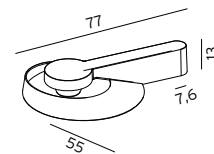



SUNNFJORD
IP65, Klasa I
Do słupa o średnicy zewnętrznej $\varnothing 76$ mm na szczycie

Akcesoria
Słup - Art. 3005, 3006, 3007: Możliwość dokupienia słupa: wraz z redukcją. (Strona 73)
Redukcja - Art.1509 Redukcja z osłoną dla oprawy Sunnfjord umożliwiającą montaż na słupie $\varnothing 60$ mm (Strona 73)

NICEA
Art. 770
70W, G12
EEI: A+

Art. 772
150W, G12
EEI: A+

Art. 777
Moduł LED: 
35,5W
5127 lm
3000K, 50000h
EEI: A++

SUNNFJORD 
Art. 1507
Moduł LED:
42,2W
6000 lm
4000K, 60000h
EEI: A++

Art. 1508 
Moduł LED:
29,3W
4342 lm
4000K, 60000h
EEI: A++





Wersja LED

VISBY

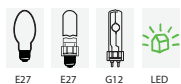

*Kolory niestandardowe Norlys za dopłatą

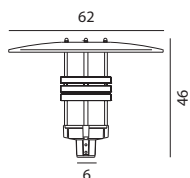

VISBY
IP65, Klasa I
Do użycia ze słupami
bądź konsolą o średnicy
zewnętrznej $\varnothing 60$ mm

Akcesoria
Art. 3005, 3006, 3007:
Możliwość dokupienia słupa:
wraz z redukcją.
(Strona 73)

Art. 154: Konsola z
ramieniem od Visby.
(Strona 72)

Art. 561
77W Halo, E27
EEI: A+..D

Art. 566
70W HSE, E27
EEI: A+

Art. 567
50-70W HSE, E27
EEI: A+

Art. 569
150W, G12
EEI: A+

Art. 575
70W, G12
EEI: A+



Art. 576 
Moduł LED:
Moduł (dół)
30,4W
3000 lm
3000K, 50000h
EEI: A+

Moduł (górn)
18,8W
2000 lm
3000K, 50000h
EEI: A+

wersja wyposażona w 2 moduły
LED – jeden moduł świecący
bezpośrednio w dół, światło
drugiego odbite od daszka



Art. 577 
Moduł LED:
Moduł (dół)
30,4W
3000 lm
3000K, 50000h
EEI: A+

wersja wyposażona w moduł
LED – światło pośrednie skierowane
w dół



HELSINKI

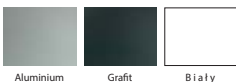

*Kolory niestandardowe Norlys za dopłatą



Czarny

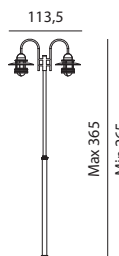
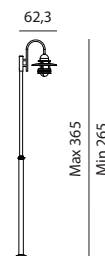
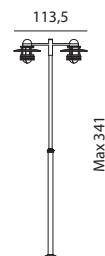
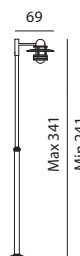
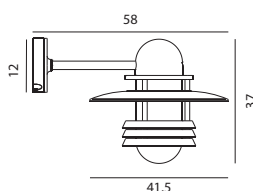
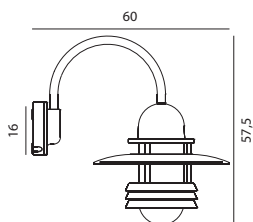

HELSINKI IP54

Klasa II: Art. 882

Klasa I: 881, 883, 88302, 885, 886, 887, 88307, 888, 889

Oprawa: odlew aluminiowy malowany proszkowo

Klosz: PC

Art. 882
77W Halo, E27, klasa II
EEI: A+..D

Art. 883
26W, G24q-3, klasa I
EEI: A+..B

Art. 88302
35W, G12, klasa I
EEI: A+

Akcesoria
Narożnik Art. 156

Art. 886
77W Halo, E27, klasa I
EEI: A+..D

Art. 887
26W, G24q-3, klasa I
EEI: A+..B

Art. 88702
35W, G12, klasa I
EEI: A+

Akcesoria
Narożnik Art. 158

Art. 888
35W, G12
EEI: A+

Art. 889
2x35W, G12
EEI: A+

Art. 881
35W, G12
EEI: A+

Art. 885
2x35W, G12
EEI: A+

Akcesoria
For Art: 881, 885, 888, 889
Kotwa - 111
Kotwa - 405
Kotwa - 406



EGERSUND MINI



LED

Dostępny w sprzedaży od stycznia 2017 roku



EGERSUND



LED



Aluminium Grafit

*Kolory niestandardowe Norlys za dopłatą



Biały Czarny Stal kortenowa

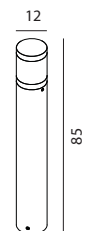
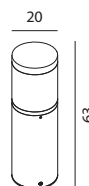

EGERSUND IP65, Klasa I

Oprawa: odlew
aluminiowy malowa-
ny proszkowo

Klosz: PC
przeźroczysty

Aksesoria

Do art. 1280 i 1285
Kotwa - 1230
Kotwa - 1231
Kotwa - 1232

Art. 1280 
Moduł LED:
17,6W
2240 lm
3000K, 50000h
EEL: A+

Art. 1285 
Moduł LED:
17,6W
2240 lm
3000K, 50000h
EEL: A+

EGERSUND MINI IP65, Klasa I

Oprawa: odlew
aluminiowy malowa-
ny proszkowo

Klosz: PC
przeźroczysty

Aksesoria

Kotwa - 1236
Kotwa - 1237
Kotwa - 1238
Dostępny w sprzedaży od
stycznia 2017 roku

Art. 1290 
Dostępny w sprzedaży
od stycznia 2017 roku





STAVANGER



LED



Aluminium Grafit

*Kolory niestandardowe Norlys za dopłatą



Biały Czarny Stal kortenowa

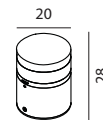
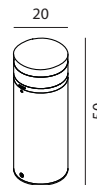
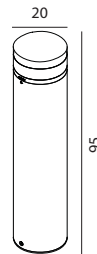

STAVANGER
IP65, Klasa I

Oprawa: odlew
alumiowy
malowany proszkowo

Klosz:
PC przezroczysty

Akcesoria
Kotwa - 1230
Kotwa - 1231
Kotwa - 1232

Art. 1240
Moduł LED:
14,7W
1380 lm
3000K, 50000h
EEI: A+

Art. 1244
Moduł LED:
14,7W
1380 lm
3000K, 50000h
EEI: A+

Art. 1247
Moduł LED:
7W
750 lm
3000K, 50000h
EEI: A+





NARVIK

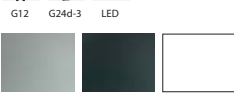

*Kolory niestandardowe Norfys za dopłatą

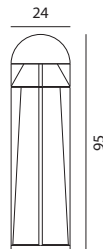

NARVIK
IP65, Klasa I

Oprawa: odlew aluminiowy
malowany proszkowo

Klosz: PC przezroczysty

Art. 552
35W, G12
EEL: A+

Art. 554
26W, G24d-3
EEL: A+..B

Art. 557 
Moduł LED:
21W
3137 lm
3000K, 50000h
EEL: A++

Akcesoria
Kotwa - 110



ARVIKA



*Kolory niestandardowe Norfys za dopłatą

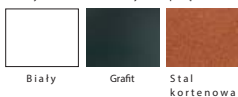

ARVIKA
IP44, Klasa I

Oprawa: Stal ocynkowana
ogniowo i malowana proszkowo

Klosz: PC przezroczysty

Akcesoria
Kotwa - 207

Art. 890
35W, G12
EEI: A+

Art. 892
18W, Gx24q-2, OSRAM DULUX T/E
EEI: B

Art. 894 (Dystrybutor)
35W, G12
EEI: A+

Art. 895 (Dystrybutor)
18W, Gx24q-2, OSRAM DULUX T/E
EEI: B

KOSTER

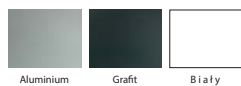

*Kolory niestandardowe Norlys za dopłatą

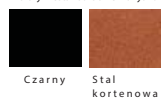

ART. 720, 1911



ART. 724, 725, 728, 1912



ART. 727, 729, 1913



ART. 1272, 1914

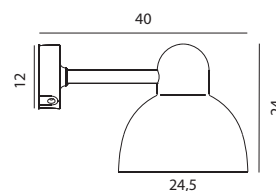
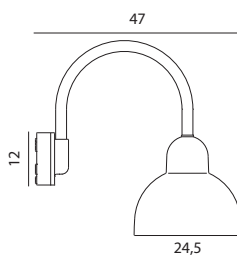

Koster Kinkiet
IP54
Klosz: PC struktura

Aksesoria
Narożnik Art. 158
For Art: 720, 724, 725,
728, 1911, 1912

Art. 720
E27, 77W Halo
Klasa II
EEI: A+...D

Art. 1911 
Klasa I
Moduł LED:
18,8W
2000 lm
3000K, 50000h
EEI: A+

Art. 724
E27, 77W Halo
Klasa I
EEI: A+...D

Art. 728
26W, G24q-3, HF
Klasa I
EEI: A+...B

Art. 725 
Klasa I
Moduł LED:
11,3W
1100 lm
3000K, 50000h
EEI: A+

Art. 1912 
Klasa I
Moduł LED:
18,8W
2000 lm
3000K, 50000h
EEI: A+

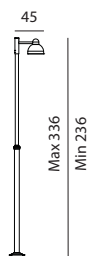
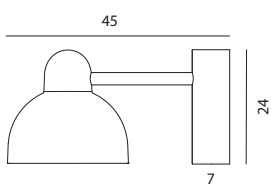



Koster głowa
IP54, Klasa I
Klosz: PC struktura

* Art. 727, 729 and 1913:
Do słupów o średnicy
ø60 mm na szczycie

Akcesoria
Art. 3005
Do Art. : 727, 729, 1913

Art. 727
26W, G24q-3, HF
EEI: A+...B

Art. 729 
Moduł LED:
11,3W
1100 lm
3000K, 50000h
EEI: A+

Art. 1913 
Moduł LED:
18,8W
2000 lm
3000K, 50000h
EEI: A+

Koster słup teleskopowy
IP54, Klasa I
Klosz: PC struktura

Akcesoria
For Art: 1272, 1914
Kotwa - 111
Kotwa - 405
Kotwa - 406

Art. 1272 
Moduł LED:
11,3W
1100 lm
3000K, 50000h
EEI: A+

Art. 1914 
Moduł LED:
18,8W
2000 lm
3000K, 50000h
EEI: A+



VOSS

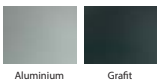

*Kolory niestandardowe Norlys za dopłatą

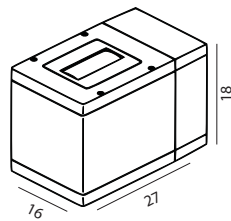

VOSS
IP54, Klasa I
Klosz: szkło bezpieczne
przeźroczyste

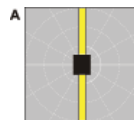

(Wersje. A)
Art. 783
70W, G12
EEI: A+

Art. 787
35W, G12
EEI: A+

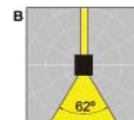

(Wersje. B)
Art. 780
70W, G12
EEI: A+

Art. 786
35W, G12
EEI: A+

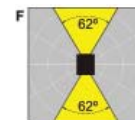

(Wersje. F)
Art. 784
70W, G12
EEI: A+

Art. 788
35W, G12
EEI: A+

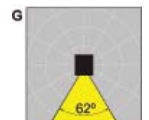

(Wersje. G)
Art. 785
70W, G12
EEI: A+

Art. 789
35W, G12
EEI: A+

Art. 1950 
Moduł LED:
3x6,4W
1830 lm
3000K, 50000h
EEI: A+

Art. 1951 
Moduł LED:
2x6,4W
1220 lm
3000K, 50000h
EEI: A+

KIRUNA



G24d-3



Aluminium Grafit

*Kolory niestandardowe Norlys za dopłatą



Bialy Czarny Stal kortenowa



ARENDAL



E14



Czarny Grafit

*Kolory niestandardowe Norlys za dopłatą



Bialy Stal kortenowa

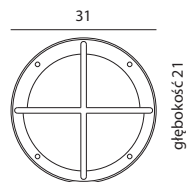

głębokość 21

KIRUNA
IP66, Klasa II
Odporność: IK10
Klosz: PC mleczny

wandaloodporna,
4 mm klosz z poliwęglanu

KIRUNA
Art. 594
26W, G24d-3
EEI: A+...B

ARENDAL
IP65, Klasa II
Klosz: szkło kryształ

W oprawach Arendal
może wystąpić delikatna
kondensacja, powinna
ustąpić po włączeniu oprawy.

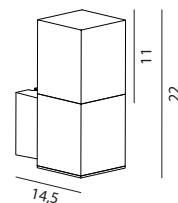

ARENDAL
Art. 1250
E14, 46W. max
EEI: A+...D



SANDE



GU10 LED

LED



Czarny

Grafit

*Kolory niestandardowe Norliss za dopłatą



Biały

Stal kortenowa

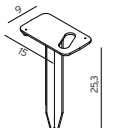
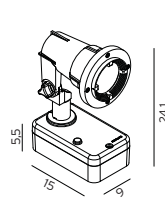
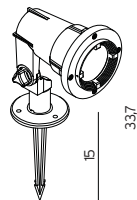
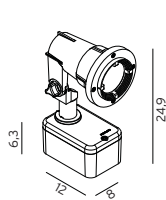

SANDE IP65, Klasa I

Oprawa: odlew aluminiowy malowany proszkowo

Klosz: szkło bezpieczne przezroczyste lub satynowane

Art. 1590 (ścienna) 4W LED, GU10, 250 lm 3000K, 40000h, 40D EEI: A+

Art. 1591 (ścienna) Moduł LED: 7W 750lm 3000K, 50000h, 40D EEI: A+

Art. 1592 (ścienna/ziemna) 4W LED, GU10, 250 lm 3000K, 40000h, 40D EEI: A+

Art. 1593 (ścienna/ziemna) Moduł LED: 7W 750lm 3000K, 50000h, 40D EEI: A+

Art. 1594 (ziemna) Moduł LED: 7W 750lm 3000K, 50000h, 40D EEI: A+

Art. 1598 (ziemna) 4W LED, GU10, 250 lm 3000K, 40000h, 40D EEI: A+

Art. 1596 (ziemna) Moduł LED: 7W 750lm 3000K, 50000h, 40D EEI: A+

Art. 1599 (ziemna) 4W LED, GU10, 250 lm 3000K, 40000h, 40D EEI: A+

Akcesoria Przysłona - 1233

**Akcesoria
Kotwa - 1234**
For Art:
Art. 1594
Art. 1596
Art. 1598
Art. 1599

* z 5-cio metrowym przewodem oraz grotem
Do montażu ściennego należy usunąć grot



RENA



GU10
LED



Nierdzewna stal
szlachetna

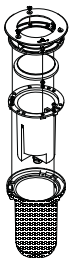
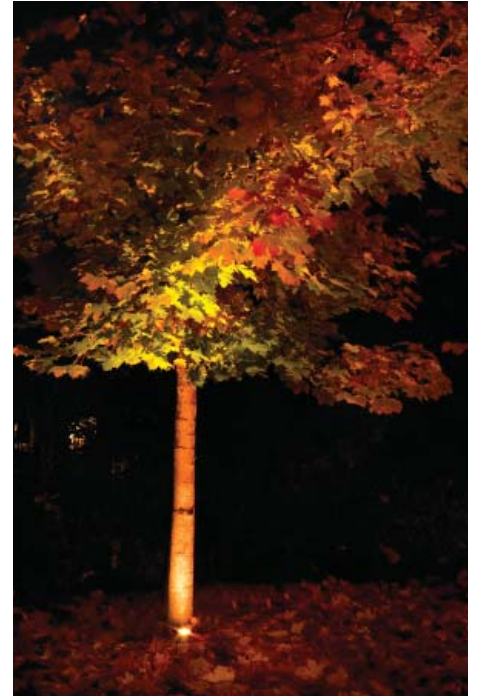

Rena

IP68(1m), Klasa I

Korpus: odlew aluminium malowany proszkowo.

Puszka: polipropylen.

Front: nierdzewna stal szlachetna.

Klosz: szkło hartowane, przezroczyste lub satynowane.

Oprawa oświetleniowa do montażu w podłożu, korpus z odlewu aluminium malowany proszkowo, pokrywa ze stali nierdzewnej 316L, szkło bezpieczne (max. 2000 kg), 3 metrowy przewód zasilający. (PG ze stali nierdzewnej dla przewodu 8-12 mm). Puszka montażowa z polipropylenu w zestawie.

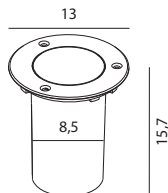

Art. 1550

Okrągła



Klosz: przezroczysty
5,4W LED, GU10, 378 lm
2700K, 50000h, 40D
EEI: A+

Art. 1552

Okrągła

Klosz: przezroczysty
6W max., GU 10
EEI: A+..D

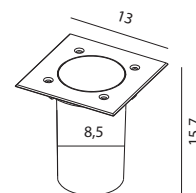

Art. 1551

Kwadratowa



Klosz: przezroczysty
5,4W LED, GU10, 378 lm
2700K, 50000h, 40D
EEI: A+

Art. 1553

Kwadratowa

Klosz: przezroczysty
6W max., GU 10
EEI: A+..D

Art. 1555

Kwadratowa



Klosz: satynowany
5,4W LED, GU10, 378 lm
2700K, 50000h, 40D
EEI: A+

Art. 1557

Kwadratowa

Klosz: satynowany
6W max., GU 10
EEI: A+..D



GRIMSTAD



LED E14



Aluminium Grafit

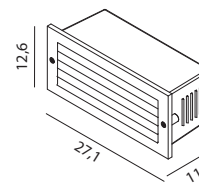
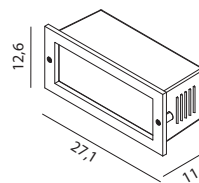

GRIMSTAD IP65, Klasa I

Korpus: odlew aluminiowy
malowany proszkowo
Puszka montażowa:
polipropylen
Klosz: szkło mleczne

Art. 1544 
Moduł LED:
4W
592 lm
3000K, 50000h
EEI: A++

Art. 1546
E14, 46W. max
EEI: A+...D

Art. 1545 
Moduł LED:
6,8W
981 lm
3000K, 60000h
EEI: A++

Art. 1547
E14, 46W. max
EEI: A+...D

NAMSOS



LED



Aluminium Grafit

*Kolory niestandardowe Norlys za dopłatą



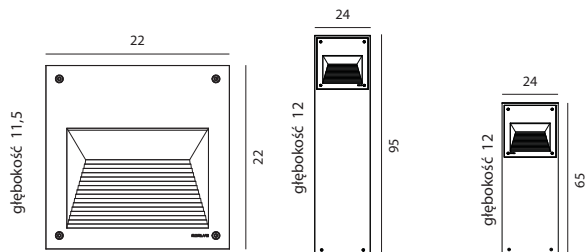
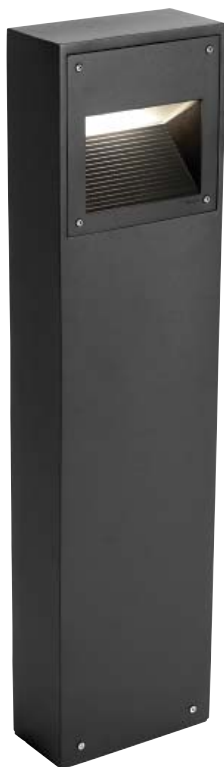

Biały Czarny Stal kortenowa



NAMSOS
IP65, Klasa I

Korpus: odlew aluminiowy
malowany proszkowo
Puszka montażowa:
polipropylen
Klosz: szkło satynowane

Art. 1930 
Moduł LED:
10,1W
1376 lm
3000K, 50000h
EEL: A++

Art. 1931 
Moduł LED:
10,1W
1376 lm
3000K, 50000h
EEL: A++

Art. 1932 
Moduł LED:
10,1W
1376 lm
3000K, 50000h
EEL: A++

Akcesoria
Do art. 1931 i 1932
Kotwa - 112
Kotwa - 113
Kotwa - 114



ASKER

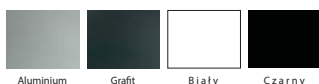

*Kolory niestandardowe Norfys za dopłatą

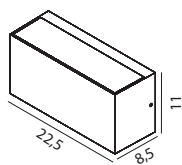
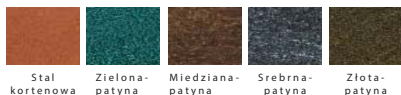

ASKER
IP65, Klasa I
Oprawa: odlew aluminiowy
malowany proszkowo
Klosz: PC struktura

Dla uzyskania optymalnej
efektywności świecenia
zalecamy wersję LED lub
18W

*Art. 1511, 1514, 1517
Uwaga: Nie obracać tylnej płyty.
Wybór kierunku świecenia poprzez
obrót frontu.



Art.1510
Moduł LED:
8,6W
800 lm
50000h, 3000k
EEI: A

Art.1513
E27, 46W Halo
EEI: A+..D

Art.1516
18W, G24q-2, HF
EEI: A+..B

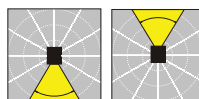

Art.1511
Moduł LED:
8,6W
800 lm
50000h, 3000k
EEI: A

Art.1514
E27, 46W Halo
EEI: A+..D

Art.1517
18W, G24q-2, HF
EEI: A+..B

*Art. 1511, 1514, 1517
Uwaga: Nie obracać tylnej płyty. Wybór
kierunku świecenia poprzez obrót frontu.

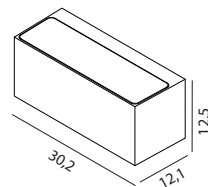

ASKER
IP65, Klasa I
Oprawa: odlew aluminiowy
malowany proszkowo
Klosz: PC struktura

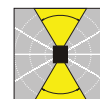

Art. 1300
Moduł LED:
2x3,9W
2x592 lm
3000K, 50000h
EEI: A+..D

Art. 1303
E27, 46W Halo
EEI: A+..D



LILLEHAMMER



LED

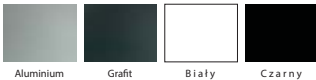

*Kolory niestandardowe Norlys za dopłatą



Stal kortenowa

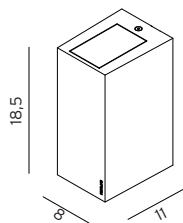

LILLEHAMMER
IP65, klasa I

Oprawa:
odlew aluminium
malowany
proszkowo

Klosz:
szkło bezpieczne
przezroczyste

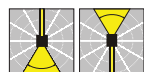

Art. 1580 
Moduł LED:
2x3,2W LED
2x305 lm
3000K, 50000h
EEI: A+



Art. 1581 
Moduł LED:
2x3,2W LED
2x305 lm
3000K, 50000h
EEI: A+



Art. 1582 
Moduł LED:
3,2W LED
305 lm
3000K, 50000h
EEI: A+



Art. 1583 
Moduł LED:
2x3,2W LED
2x305 lm
3000K, 50000h
EEI: A+



Art. 1584 
Moduł LED:
3,2W LED
305 lm
3000K, 50000h
EEI: A+



BODEN



*Kolory niestandardowe Norlys za dopłatą

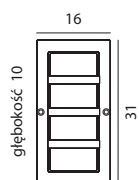
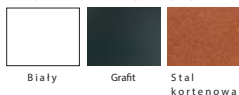

BODEN
IP54, Klasa I

Odlew aluminiowy malowany proszkowo

Podstawa aluminiowa, front miedziany, ocynkowany lub malowany proszkowo

Klosz: PC mleczny lub przezroczysty

Art.860
E27, 46W Halo. max
PC mleczny
EEI: A+,D

Art.862
E27, 46W Halo. max
PC przezroczysty
EEI: A+,D

Art. 866
PC mleczny
Moduł LED:
8,7W
660 lm
49000h, 3000K
EEI: A

Do wyczerpania
zapasów

Art. 867
PC mleczny
Moduł LED:
13W LED
1010 lm
39000h, 3000K
EEI: A

Do wyczerpania
zapasów

NORDKAPP

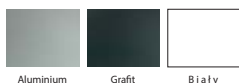
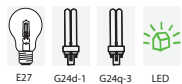

*Kolory niestandardowe Norlys za dopłatą

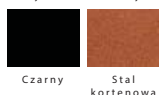

NORDLAND

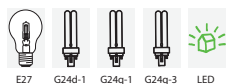

*Kolory niestandardowe Norlys za dopłatą

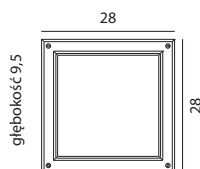
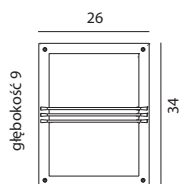

NORDKAPP IP65, klasa I

Oprawa:
odlew aluminiowy
malowany
proszkowo

Klosz: PC mleczny

NORDKAPP Art. 524

18W, G24d-2
EEI: A+..B

Art. 52401
2x max 10W, E27, LED
EEI: A+..D

Art. 1490
2x26W, G24q-3, HF
EEI: A+..B

NORDKAPP Art. 1620

Moduł LED:
11,3W
1100 lm
3000K, 50000h
EEI: A+



NORDLAND IP65, klasa I

Oprawa:
odlew aluminiowy
malowany
proszkowo

Klosz: PC mleczny

Nordland -
możliwość montażu
ściennego oraz na
suficie

NORDLAND Art. 710

10-13W, G24d-1
EEI: A+..B

Art. 712
2x10-13W, G24d-1
EEI: A+..B

Art. 71200
2x max 10W, E27,
LED
EEI: A+..D

NORDLAND Art. 713

2x13W, G24q-1, HF
EEI: A+..B

Art. 714
26W, G24q-3, HF
EEI: A+..B

Art. 715
2x26W, G24q-3, HF
EEI: A+..B

NORDLAND Art. 718

Moduł LED:
11,3W
1100 lm
3000K, 50000h
EEI: A+



Art. 719
Moduł LED:
13,6W
1500 lm
3000K, 50000h
EEI: A+





SANDVIK



GU 10
LED



Aluminium Grafit Biały Czarny

*Kolory niestandardowe Norlys za dopłatą



Stal
kortenowa

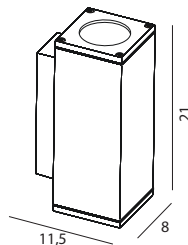

Art. 791
2x25W max, GU 10
EEI: A+..D

Art. 792
2x4W LED, GU10, 2x250 lm, 25D, 2700K, 50000h
EEI: A+

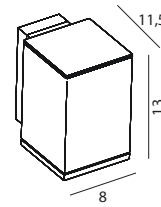

Art. 793
25W max, GU 10
EEI: A+..D

Art. 794
4W LED, GU10, 250 lm, 25D, 2700K, 50000h
EEI: A+

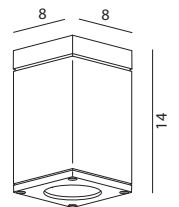

Art. 795
25W max, GU 10
EEI: A+..D

Art. 796
4W LED, GU10, 250 lm, 25D, 2700K, 50000h
EEI: A+



RONDANE

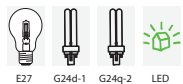

*Kolory niestandardowe Norlys za dopłatą



BORNHOLM

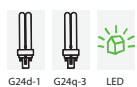

*Kolory niestandardowe Norlys za dopłatą

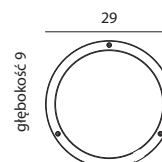
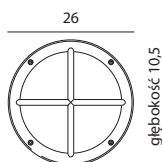

RONDANE

IP65, Klasa I

Oprawa: odlew
aluminiowy
malowany prosz-
kowo

Klosz: PC mleczny

Rondane -
możliwość montażu
ściennego oraz na
suficie

Rondane

Art. 520
10-13W, G24d-1
EEI: A+..B

Art. 531
18W, G24q-2, HF
EEI: A+..B

Rondane

Art. 537 
Moduł LED:
11,3W LED
1100 lm
3000K, 50000h
EEI: A+

Art. 538
10W max, E27, LED
EEI: A+..D

Bornholm

IP65, Klasa I

Oprawa: odlew
aluminiowy
malowany prosz-
kowo

Klosz: PC mleczny

Bornholm-
możliwość montażu
ściennego oraz na
suficie

Bornholm

Art. 522
10-13W, G24d-1
EEI: A+..B

Art. 534
26W, G24q-3, HF
EEI: A+..B

Art. 541 
Moduł LED:
11,3W LED
1100 lm
3000K, 50000h
EEI: A+

GENEVA



E27 G24q-2 LED

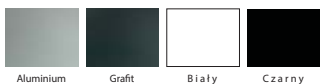

Aluminium Graft Biały Czarny

*Kolory niestandardowe Norlys za dopłatą



Stal kortenowa

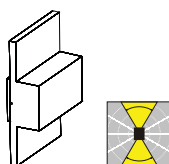
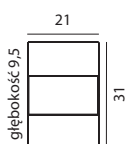

GENEVA
IP54, Klasa I

Oprawa: odlew
alumiiniowy malowany
proszkowo

Klosz: PC mleczny

Art. 874
E27, 46W Halo
EEI: A+,D

Art. 877
18W, G24q-2, HF
EEI: A+,B

Art. 879 
Moduł LED:
8,6W LED
800 lm
3000K, 50000h
EEI: A+



VASA

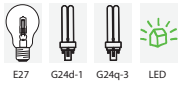

*Kolory niestandardowe Norlys za dopłatą

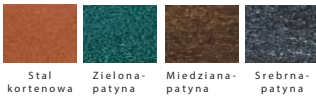

VASA
IP65, Klasa I

Oprawa: odlew
alumiowy
malowany
proszkowo

Klosz: PC struktura

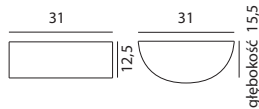

Art. 120
E27, 57W Halo
EEI: A+,D

Art. 122
18W, G24d-2
EEI: A+,B

Art. 126
26W, G24q-3, HF
EEI: A+,B

Art. 127 
9W LED,
E27 LED zawiera:
806 lm, 2700K, 25000h
EEI: A+

Art. 128 
Moduł LED:
2x3,9W
2x592lm
3000K, 50000h
EEI: A++



HALDEN

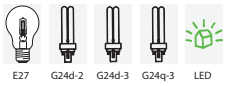

*Kolory niestandardowe Norlys za dopłatą

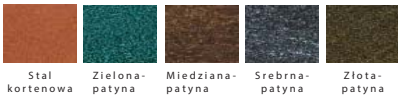

głębokość: 15,5

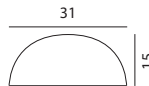

HALDEN
IP65, Klasa I

Oprawa: odlew
aluminiowy
malowany
proszkowo

Klosz: PC struktura

Art. 510
E27, 57W Halo
EEI: A+..D

Art. 512
18W, G24d-2
EEI: A+..B

Art. 514
26W, G24d-3
EEI: A+..B

Art. 515
9W, E27 
LED zawiera: 806 lm,
2700K, 25000h
EEI: A+

Art. 518
26W, G24q-3, HF
EEI: A+..B

Art. 517 
Moduł LED:
7,5W
1000 lm
3000K, 50000h
EEI: A++

BERNO



*Kolory niestandardowe Norlys za dopłatą



Biały



BAZYLEA

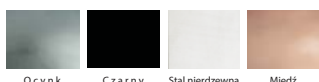

*Kolory niestandardowe Norlys za dopłatą



Biały

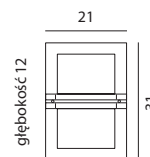
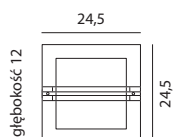

BERNO
IP54, klasa I

Podstawa aluminiowa,
front miedziany, ocynkowany,
stal nierdzewna lub stal
malowana proszkowo

BERNO
Art. 650
E27, 46W Halo
szklany przezroczysty
EEI: A+..D

Art. 651
E27, 46W Halo
satynowany
EEI: A+..D

Art. 655
satynowany
Moduł LED:
3,9W
592 lm
3000K, 50000h
EEI: A++

BERNO
Art. 656
satynowany
Moduł LED:
13W
1010 lm
3000K, 39000h
EEI: A

Art. 656 : do
wyczerpania zapasów

BAZYLEA
IP54, Klasa I

Podstawa aluminiowa,
front miedziany, ocynkowany,
stal nierdzewna lub stal
malowana proszkowo

BAZYLEA
Art. 660
E27, 57W Halo
szklany przezroczysty
EEI: A+..D

Art. 661
E27, 57W Halo
satynowany
EEI: A+..D

Art. 668
satynowany
Moduł LED:
3,9W
592 lm
3000K, 50000h
EEI: A++

BAZYLEA
Art. 669
satynowany
Moduł LED:
13W
1010 lm
3000K, 39000h
EEI: A

Art. 669: do
wyczerpania zapasów





MOLDE



LED



Aluminium Grafit

*Kolory niestandardowe Norlys za dopłatą



Czarny Stal kortenowa Biały

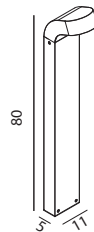

MOLDE
IP54, Klasa I

Oprawa: odlew aluminiowy
malowany proszkowo

Klosz: PC struktura

Art. 1901 
Moduł LED:
8,6W
800 lm
3000K, 50000h
EEI: A+

Akcesoria
Kotwa - Art. 1906
Kotwa - Art. 1907
Kotwa - Art. 1908



HALMSTAD



*Kolory niestandardowe Norliss za dopłatą

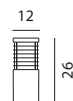

Art. 210
E27, 46W Halo
EEI: A+,D

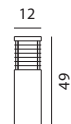

Art. 295
E27, 46W Halo
EEI: A+,D



Art. 296
E27, 46W Halo
EEI: A+,D

HALMSTAD
IP65, Klasa II
Art. 1489, 1482, Klasa I

Oprawa: stal cynkowa
ogniowo i malowana proszkowo

Klosz: PC mleczny

Akcesoria
Kotwa - Art. 205
Kotwa - Art. 206
Kotwa - Art. 206S

Art. 211
Moduł LED:
10W LED
900 lm
3000K, 50000h
EEI: A+

Art.1488
9W, E27
LED zawiera:
806 lm, 2700K, 25000h
EEI: A+

Art. 1489
Moduł LED:
10W LED
900 lm
3000K, 50000h
EEI: A+

Art. 1482
Moduł LED:
10W LED
900 lm
3000K, 50000h
EEI: A+

Art.1483
9W, E27
LED zawiera:
806 lm, 2700K,
25000h
EEI: A+

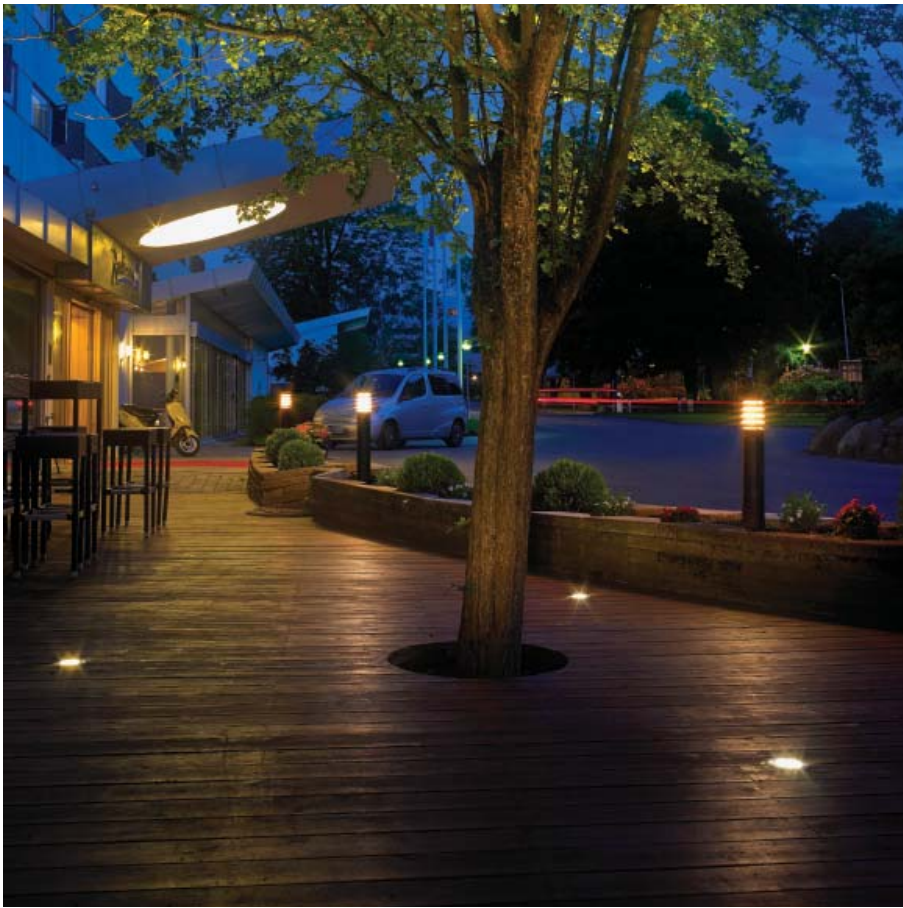

ALTA



*Kolory niestandardowe Norlys za dopłatą

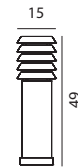
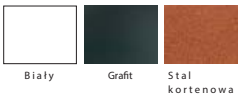

ALTA
IP65, Klasa II
Art. 1476, 1479 Klasa I

Oprawa: stal cynkowana
ogniowo i malowana proszkowo

Klosz: PC mleczny

Akcesoria

Kotwa - Art. 205
Kotwa - Art. 206
Kotwa - Art. 206S

Art. 291
E27, 46W Halo
EEI: A+..D

Art. 1475 
9W, E27
LED zawiera:
806 lm, 2700K,
25000h
EEI: A+

Art. 1479 
Moduł LED:
10W LED
900 lm
3000K, 50000h
EEI: A+

Art. 293
E27, 46W Halo
EEI: A+..D

Art. 1476 
Moduł LED:
10W LED
900 lm
3000K, 50000h
EEI: A+

Art. 1475 
9W, E27
LED zawiera:
806 lm, 2700K, 25000h
EEI: A+

SKANDYNAWSKIE DREWNO



Nasz nowy asortyment drewnianych słupków idealnie wpisuje się w wiele różnorodnych projektów, łącząc nowoczesne oświetlenie i naturalne materiały. Wykorzystujemy pierwszy gatunek sosny skandynawskiej, impregnowanej w celu jej jak najlepszej ochrony. Drewniany korpus występuje w wersji impregnowanej bądź dwukrotnie malowanej. Oznaczenie * - wersja tylko impregnowana*:wybarwienie na życzenie klienta. Elementy z drewna skandynawskiego należy konserwować zgodnie z zaleceniami wskazanymi w Ogólnych Warunkach Użytkowania Norlys Sp. z o.o.

Elementy z drewna skandynawskiego objęte są dwuletnią gwarancją pod warunkiem, zalecanej w Ogólnych Warunkach Użytkowania, odpowiedniej corocznej konserwacji.



HALMSTAD



STOCKHOLM



ALTA

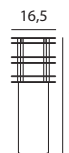
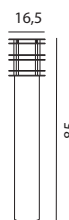
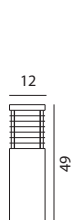

SKANDYNAWSKIE DREWNO IP65, Klasa II

Oprawa: drewno ze skandynawskiej sosny, malowane lub impregnowane
Okucia: stalowe okucia malowane proszkowo i cynkowane ogniowo
Klosz: PC mleczny

Halmstad (drewno)
Art. 1400
E27, 46W Halo
EEI: A+..D

***Art. 1403**
E27, 46W Halo
EEI: A+..D

Halmstad (drewno)
Art. 1410
E27, 46W Halo
EEI: A+..D

***Art. 1413**
E27, 46W Halo
EEI: A+..D

Stockholm (drewno)
Art. 1420
E27, 46W Halo
EEI: A+..D

***Art. 1423**
E27, 46W Halo
EEI: A+..D

Stockholm (drewno)
Art. 1430
E27, 46W Halo
EEI: A+..D

***Art. 1433**
E27, 46W Halo
EEI: A+..D

Alta (drewno)
Art. 1440
E27, 46W Halo
EEI: A+..D

***Art. 1443**
E27, 46W Halo. max.
EEI: A+..D

Alta (drewno)
Art. 1450
E27, 46W Halo
EEI: A+..D

***Art. 1453**
E27, 46W Halo
EEI: A+..D

Aksesoria
Kotwa - Art. 205
Kotwa - Art. 206
Kotwa - Art. 206S



STOCKHOLM



E27

LED



O cynk

Czarny

*Kolory niestandardowe Norliss za dopłatą



Biały

Grafit

Stal kortenowa

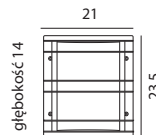

STOCKHOLM IP54, Klasa I

Podstawa: odlew aluminiowy
malowany proszkowo

Front: stal cynkowana ogniowo

Klosz: PC przezroczysty lub
mleczny

Art. 220
E27, 46W Halo
Klosz: PC mleczny
EEI: A+,D

Art. 226
E27, 46W Halo
PC przezroczysty
EEI: A+,D

Art. 1600 
PC mleczny
Moduł LED:
8,6W
800 lm
3000K, 50000h
EEI: A+



STOCKHOLM



*Kolory niestandardowe Norliss za dopłatą

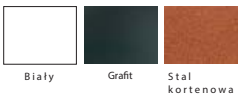

16,5



Art. 288
E27, 46W Halo
PC mleczny
EE: A+,D

16,5

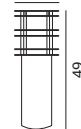

Art. 289
E27, 46W Halo
PC mleczny
EE: A+,D

16,5

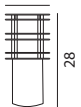

Art. 299
E27, 46W Halo
PC mleczny
EE: A+,D

STOCKHOLM
IP65, Klasa II
Art. 1260, 1265: Klasa I

Stal cynkowa ognioowo i malowana proszkowo w standardzie

Klosz: PC mleczny (opcjonalnie możliwość zamówienia klosza przezroczystego)

Aksesoria
Kotwa - Art. 205
Kotwa - Art. 206
Kotwa - Art. 206S

Art. 297
E27, 46W Halo
PC przezroczysty
EE: A+,D

Art. 1265
PC mleczny
Moduł LED:
10W LED
900 lm
3000K, 50000h
EE: A+

Art. 298
E27, 46W Halo
PC przezroczysty
EE: A+,D

Art. 1260
PC mleczny
Moduł LED:
10W LED
900 lm
3000K, 50000h
EE: A+

Art. 1268
PC mleczny
Moduł LED:
10W LED
900 lm
3000K, 50000h
EE: A+



ART. 286



STOCKHOLM



E27



Ocynk Czarny Miedz Biały

*Kolory niestandardowe Norfys za dopłatą



Graft Stal kortenowa

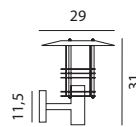
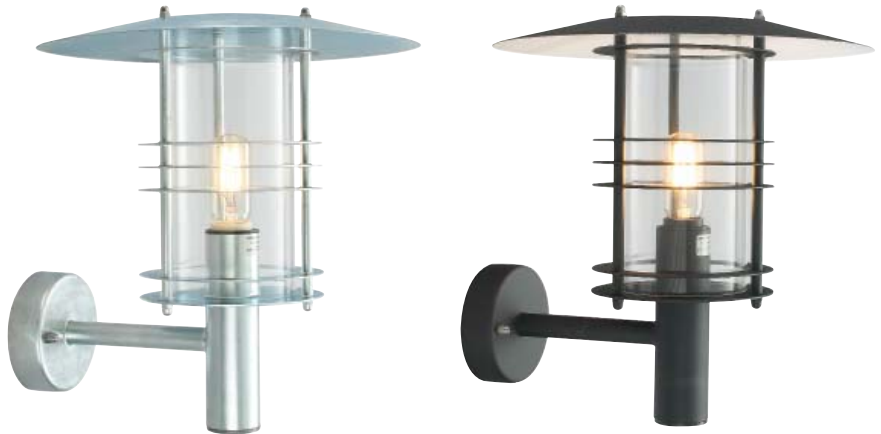

Art. 280
E27, 46W Halo
EEI: A+..D

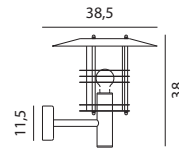

Art. 286
E27, 77W Halo
EEI: A+..D

STOCKHOLM
IP54, Klasa II

Oprawa: stal cynkowa
ogniowo i malowana
proszkowo w standardzie
(opcjonalnie możliwość
zamówienia oprawy
wykonanej z miedzi
zabezpieczonej
chemicznie)

Klosz: PC przezroczysty

Akcesoria
Narożnik Art. 153

Akcesoria
Narożnik Art. 153

(Art. 280- tylko miedz)



STOCKHOLM



E27



O cynk Czarny Biały

*Kolory niestandardowe Norfys za dopłatą

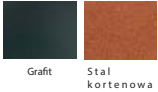

Grafit Stal kortenowa

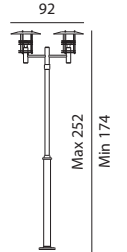
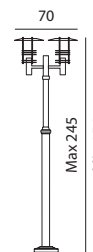
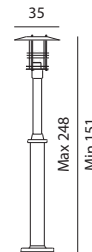
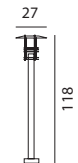
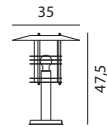
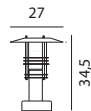

STOCKHOLM IP54, Klasa II

Oprawa : stal cynkowa
ogniowo i malowana
proszkowo w standardzie,
słupy: stal cynkowana
ogniowo lub aluminium
malowane proszkowo

Klosz: PC przezroczysty

Art. 284
E27, 46W Halo
EEI: A+..D

Art. 287
E27, 46W Halo
EEI: A+..D

Art. 285
E27, 46W Halo
EEI: A+..D

Art. 281
E27, 77W Halo
EEI: A+..D

Art. 282
E27, 2x77W Halo
EEI: A+..D

Art. 283
E27, 2x77W Halo
EEI: A+..D

Kotwy do betonu w zestawie dla Art. 284, 287 i 285

Akcesoria

Do art. 281, 282 i 283.
Kotwa - 111
Kotwa - 405
Kotwa - 406

BERLIN



*Kolory niestandardowe Norlys za dopłatą



HAMBURG



*Kolory niestandardowe Norlys za dopłatą

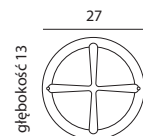
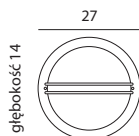

BERLIN
IP54, Klasa I

Oprawa: odlew aluminiowy malowany proszkowo

Klosz: PC mleczny lub przezroczysty

BERLIN
Art. 610
PC przezroczysty
E27, 46W Halo
EEI: A+..D

Art. 611
PC mleczny
E27, 46W Halo
EEI: A+..D

BERLIN
Art. 615 
PC mleczny
9W LED, E27
LED zawiera:
806 lm, 2700K, 25000h
EEI: A+

Art. 617 
PC mleczny
Moduł LED:
11,3W
1100 lm
3000K, 50000h
EEI: A+

HAMBURG
IP54, Klasa I

Oprawa: odlew aluminiowy malowany proszkowo

Klosz: PC mleczny lub przezroczysty

HAMBURG
Art. 620
E27, 46W Halo
PC przezroczysty
EEI: A+..D

Art. 621
E27, 46W Halo
PC mleczny
EEI: A+..D

BREMEN

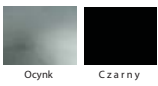

*Kolory niestandardowe Norlys za dopłatą

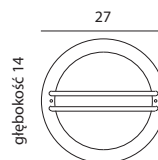
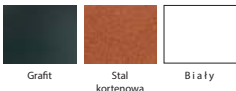

BREMEN
IP54, Klasa I

Oprawa:

Klosz: PC mleczny
lub przezroczysty

Art. 630
E27, 46W Halo
PC przezroczysty
EEI: A+,D

Art. 631
E27, 46W Halo
PC mleczny
EEI: A+,D

Art. 637 
PC mleczny
Moduł LED:
11,3W
1100 lm
3000K, 50000h
EEI: A+



OSLO

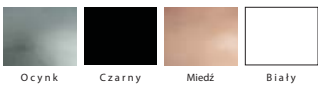

*Kolory niestandardowe Norfys za dopłatą

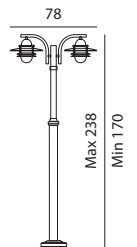
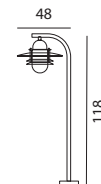
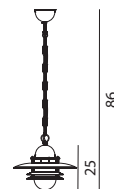
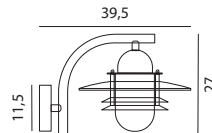
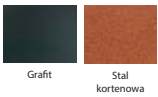

OSLO
IP55, Klasa II

Oprawa: stal cynkowana
ogniowo lub malowana
proszkowo (możliwość
zamówienia w miedzi)

Klosz: PC lub szklany -
przezroczysty lub
satynowany

(Tylko Art. 240 oraz 240A
w wykonaniu z miedzi)

Art. 240
E27, 57W Halo
EEI: A+..D

Akcesoria
Narożnik Art. 153

Art. 240A
E27, 57W Halo
EEI: A+..D

Art. 245
E27, 57W Halo
EEI: A+..D

Akcesoria
W zestawie z
kotwami do betonu.

Art. 242
E27, 2x57W Halo
EEI: A+..D

Akcesoria
Kotwa - 111
Kotwa - 405
Kotwa - 406

PARIS



*Kolory niestandardowe Norlys za dopłatą

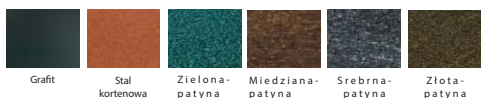

PARIS
IP43, Klasa I

Oprawa: stal malowana proszkowo, stal cynkowana ogniowo lub miedz zabezpieczona chemicznie

Klosz: PC struktura

(Tylko Art. 160 w wykonaniu z miedzi)

głębokość 14

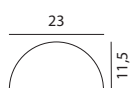

Art. 160
E27, 30W Halo
EEI: A+,D

Art. 1495 
Moduł LED:
3,9W
592lm
3000K, 50000h
EEI: A++

głębokość 16

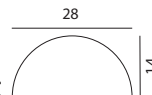

Art. 163
E27, 46W Halo
EEI: A+,D

Art. 1496 
Moduł LED:
3,9W
592lm
3000K, 50000h
EEI: A++



LUND



E27



O cynk Czarny

*Kolory niestandardowe Norlys za dopłatą



Biały Grafit Stal kortenowa

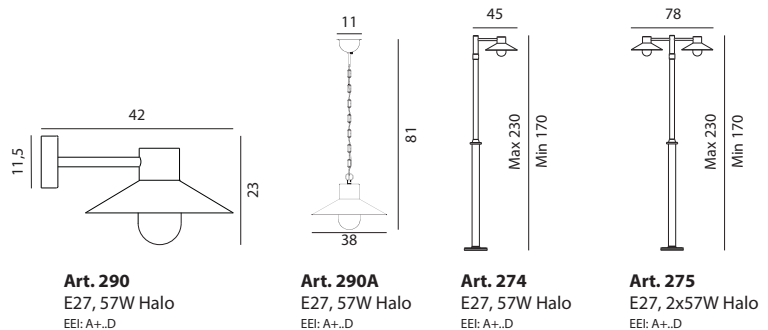

LUND
IP55, Klasa II

Oprawa: stal cynkowa
ogniwo lub malowana
proszkowo

Klosz: PC lub szklany
przezroczysty lub
satynowany

Art. 290
E27, 57W Halo
EEI: A+..D

Akcesoria
Narożnik Art. 153

Art. 290A
E27, 57W Halo
EEI: A+..D

Art. 274
E27, 57W Halo
EEI: A+..D

Akcesoria
Do art. 274 i 275.
Kotwa - 111
Kotwa - 405
Kotwa - 406

Art. 275
E27, 2x57W Halo
EEI: A+..D



KARLSTAD

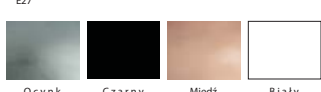

*Kolory niestandardowe Norfys za dopłatą

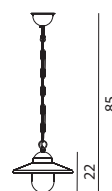
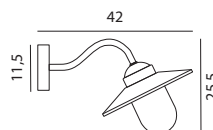
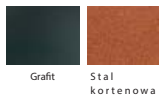

KARLSTAD
IP55, Klasa II

Oprawa:
stal malowana proszkowo
lub cynkowana ogniowo
(opcjonalnie możliwość
zamówienia w miedzi)

Klosz: PC lub szklany
przezroczysty lub
satynowany

Art. 230
E27, 57W Halo
EE: A+,D

Akcesoria
Narożnik Art. 153

Art. 230A
E27, 57W Halo
EE: A+,D

BERGEN



E27



Ocynk Czarny Biały

*Kolory niestandardowe Norfys za dopłatą



Grafit Stal kortenowa



VANSBRO



E27



Ocynk Czarny Miedź Biały

*Kolory niestandardowe Norfys za dopłatą



Grafit Stal kortenowa

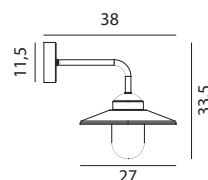
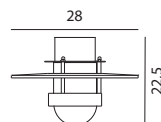
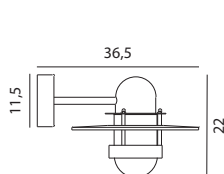

BERGEN
IP55, Klasa II

Oprawa:
stal malowana
proszkowo lub
cynkowana ogniowo

Klosz: PC lub szklany
przeźroczysty lub
satynowany

BERGEN
Art. 270
E27, 57W Halo
EEI: A+..D

Akcesoria
Narożnik Art. 153

BERGEN
Art. 271
E27, 57W Halo
EEI: A+..D

VANSBRO
IP55, Klasa II

Oprawa: stal malowana
proszkowo lub cynkowana
ogniowo

Klosz: szklany lub PC

VANSBRO
Art. 1920
E27, 57W Halo
EEI: A+..D

Akcesoria
Narożnik Art. 153





CHELSEA



E27



Miedź

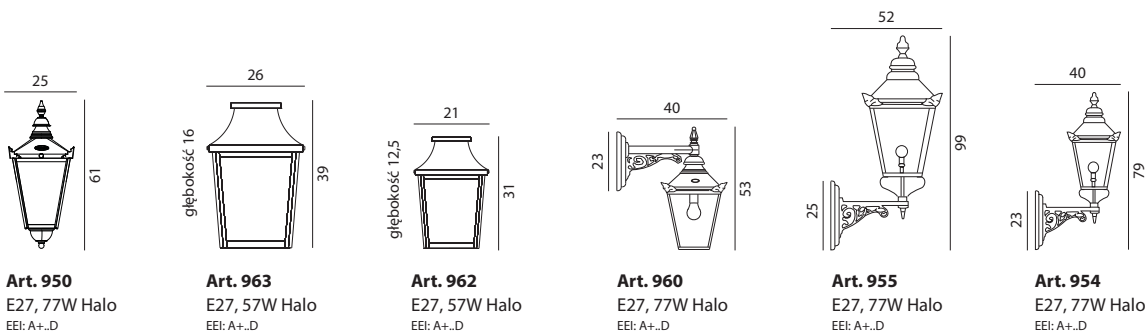

CHELSEA
IP44, Klasa II

Art. 950
E27, 77W Halo
EEI: A+,D

Art. 963
E27, 57W Halo
EEI: A+,D

Art. 962
E27, 57W Halo
EEI: A+,D

Art. 960
E27, 77W Halo
EEI: A+,D

Art. 955
E27, 77W Halo
EEI: A+,D

Art. 954
E27, 77W Halo
EEI: A+,D

Oprawa: miedź polerowana
i odlew aluminiowy
malowany proszkowo

Klosz: PC przezroczysty

Akcesoria
Narożnik Art. 152

Akcesoria
Narożnik Art. 152

Akcesoria
Narożnik Art. 152

CHELSEA



E27



Miedź

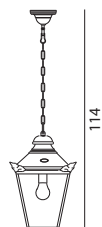

Art. 961
E27, 77W Halo
EEI: A+..D

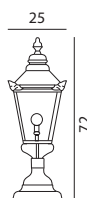

Art. 956
E27, 77W Halo
EEI: A+..D

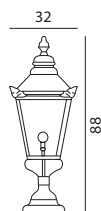

Art. 957
E27, 77W Halo
EEI: A+..D

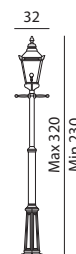

Art. 951
E27, 77W Halo
EEI: A+..D

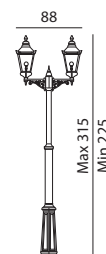

Art. 953
E27, 2x77W Halo
EEI: A+..D

CHELSEA
IP44, Klasa II

Oprawa: miedź
polerowana i odlew
aluminiowy malowany
proszkowo

Klosz: PC przezroczysty

Akcesoria
Kotwa - 307

Akcesoria
Kotwa - 307

Akcesoria Art 951, 953
Kotwa - 108
Kotwa - 305
Kotwa - 306
Stup - 3010
Stup - 30101

LOFOTEN



E27



Czarny

*Kolory niestandardowe Norfys za dopłatą



Biały

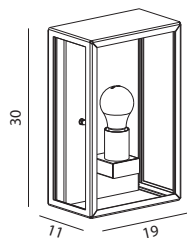

LOFOTEN
IP44, Klasa II

Art. 1940
E27, 57W Halo
EEL: A+,D

Oprawa: stal malowana
proszkowo

Klosz: przezroczyste szkło
bezpieczne hartowane

ROMA



WENECJA



TORINO



GENUA / GENUA MINI



ART. 170

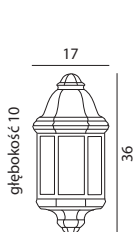

ROMA
Art. 169
E27, 46W Halo
IP54, Klasa II
EEI: A+..D



WENECJA
Art. 261
E27, 46W Halo
IP54, Klasa II
EEI: A+..D



TORINO
Art. 750
E27, 46W Halo
IP54, Klasa II
EEI: A+..D

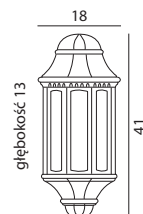

GENUA
Art. 170
E27, 46W Halo
IP54, Klasa II
EEI: A+..D



GENUA MINI
Art. 175
E27, 46W Halo
IP54, Klasa II
EEI: A+..D

GLASGOW



Czarny Bialy

*Kolory niestandardowe Norlys za dopłatą



Grafit Zielona-patyna Miedziana-patyna Srebrna-patyna Złota-patyna



LATINA



E27



CORTINA



E27

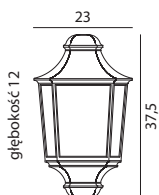

GLASGOW
Art. 730
E27, 46W Halo. max.
IP54, klasa II
EEI: A+..D

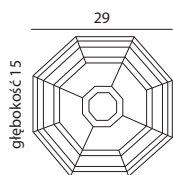

LATINA
Art. 105
E27, 46W Halo. max.
IP44, klasa II
EEI: A+..D

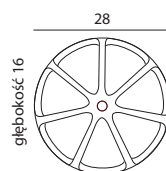

CORTINA
Art. 700
E27, 46W Halo. max.
IP54, klasa II
EEI: A+..D



RIMINI/MILANO



E27



*Kolory niestandardowe Norllys za dopłatą

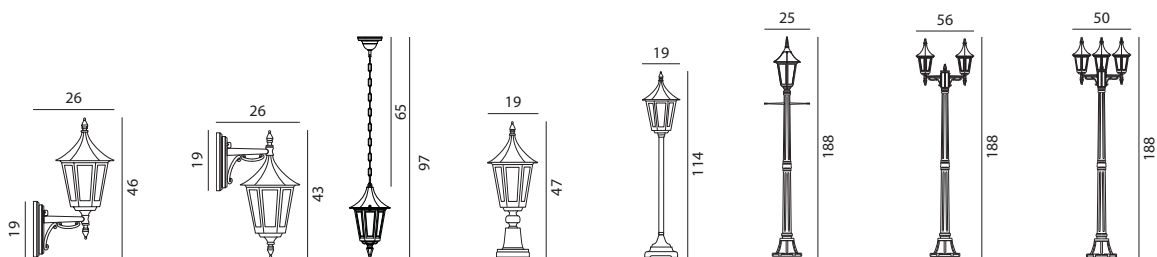

RIMINI/MILANO
IP54, Klasa II

Oprawa: odlew aluminiowy
malowany proszkowo

Klosz: PC przezroczysty

Art. 259
E27, 46W
EEI: A+..D

Aksesoria

Narożnik Art. 150 do art. 259 i 2591.

Art. 2591
E27, 46W
EEI: A+..D

Art. 2591A
E27, 46W
EEI: A+..D

Art. 250
E27, 46W
EEI: A+..D

Aksesoria

Kotwa - 307 do art. 250 i 404

Art. 404
E27, 46W
EEI: A+..D

Art. 401
E27, 77W
EEI: A+..D

Aksesoria

Kotwa - 111
Kotwa - 405
Kotwa - 406
Do art. 401, 402 i 403

Art. 402
E27, 2x46W
EEI: A+..D

Art. 403
E27, 3x46W
EEI: A+..D



BOLONIA



E27



Czarny Bialy

*Kolory niestandardowe Norlisy za dopłatą



Grafit Zielona-patyna Miedziana-patyna Srebrna-patyna Złota-patyna

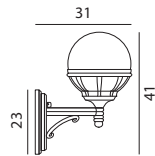

Art. 360
E27, 46W Halo
przeźroczysty
EEI: A+..D

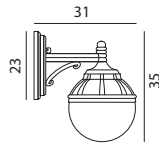

Art. 310
E27, 46W Halo
przeźroczysty
EEI: A+..D



Art. 312
E27, 46W Halo
przeźroczysty
EEI: A+..D

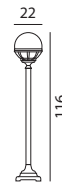

Art. 314
E27, 46W Halo
przeźroczysty
EEI: A+..D

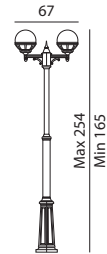

Art. 362
E27, 2x46W Halo
przeźroczysty
EEI: A+..D

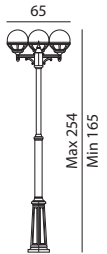

Art. 364
E27, 3x46W Halo
przeźroczysty
EEI: A+..D

BOLONIA
IP54, Klasa II

Oprawa: odlew aluminiowy
malowany proszkowo

Klosz: akryl przeźroczysty
lub mleczny

Art. 361
E27, 46W Halo
mleczny
EEI: A+..D

Art. 311
E27, 46W Halo
mleczny
EEI: A+..D

Art. 313
E27, 46W Halo
mleczny
EEI: A+..D

Art. 315
E27, 46W Halo
mleczny
EEI: A+..D

Art. 363
E27, 2x46W Halo
mleczny
EEI: A+..D'

Art. 365
E27, 3x46W Halo
mleczny
EEI: A+..D

Akcesoria
Narożnik Art. 152 do art. 310, 311, 360 i 361

Akcesoria
Kotwa - 307 do art. 312, 313, 314 i 315

Akcesoria
Do art. 362, 363, 364, 365
Kotwa - 108
Kotwa - 305
Kotwa - 306
Słup - 3010
Słup - 30101

LONDON



E27



Czarny Bialy

*Kolory niestandardowe Norfys za dopłatą



Graft Zielona-patyna Miedziana-patyna Srebrna-patyna Złota-patyna



LONDON RODZINA →

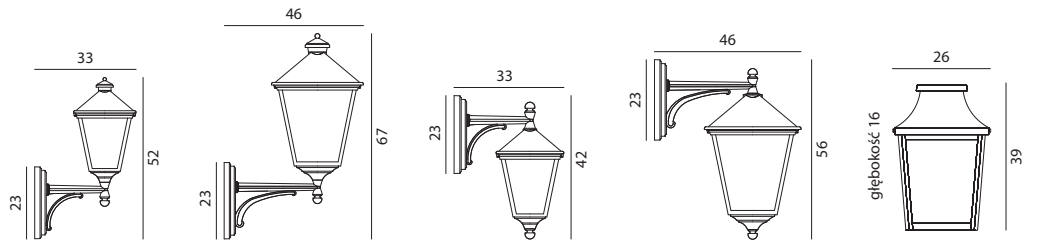

LONDON
IP54, Klasa II

Art: 497: IP65

Oprawa: odlew
alumiowy malowany
proszkowo

Klosz: PC przezroczysty

Art. 480
E27, 77W Halo
EE: A+,D

Aksesoria

Narożnik Art. 152 do art. 480, 481, 490 i 493

Art. 490
E27, 77W Halo
EE: A+,D

Art. 481
E27, 77W Halo
EE: A+,D

Art. 493
E27, 77W Halo
EE: A+,D

Art. 497
E27, 57W Halo
EE: A+,D



LONDON



E27



Czarny Biały

*Kolory niestandardowe Norlys za dopłatą



Grafit Zielona-patyna Miedziana-patyna Srebrna-patyna Złota-patyna

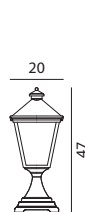

LONDON
IP54, Klasa II

Oprawa: odlew
aluminiowy malowany
proszkowo

Klosz: PC przezroczysty

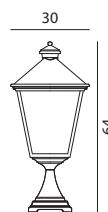

Art. 484
E27, 77W Halo
EE: A+,D

Art. 494
E27, 77W Halo
EE: A+,D

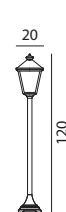

Art. 485
E27, 77W Halo
EE: A+,D

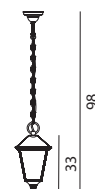

Art. 481A
E27, 77W Halo
EE: A+,D

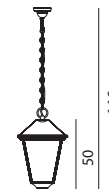

Art. 493A
E27, 77W Halo
EE: A+,D

Akcesoria

Kotwa - 307 do art. 484, 485 i 494.

LONDON

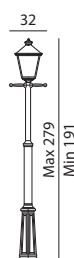

Art. 491
E27, 77W Halo
EEI: A+,D

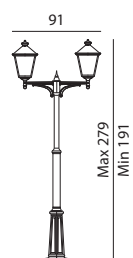

Art. 492
E27, 2x77W Halo
EEI: A+,D

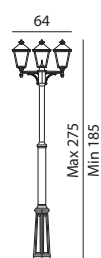

Art. 483
E27, 3x77W Halo
EEI: A+,D

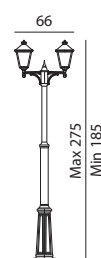

Art. 482
E27, 2x77W Halo
EEI: A+,D

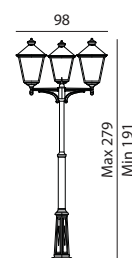

Art. 495
E27, 3x77W Halo
EEI: A+,D

LONDON
IP54, Klasa II

Oprawa: odlew aluminiowy
malowany proszkowo

Klosz: PC przezroczysty

Akcesoria

Do art. 482, 483, 491, 492 i 495

Kotwa - 108

Kotwa - 305

Kotwa - 306

Słup - 3010

Słup - 30101



MODENA



E27



Czarny Biały

*Kolory niestandardowe Norlys za dopłatą



Grafit Zielona-patyna Miedziana-patyna Srebrna-patyna Złota-patyna

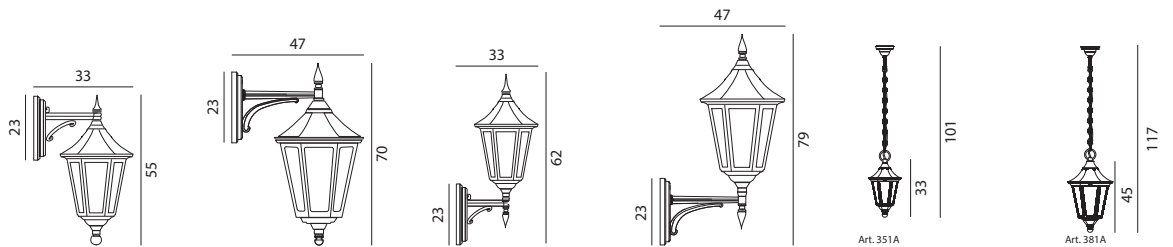

MODENA
IP54, Klasa II

Oprawa: odlew aluminium
malowany proszkowo

Klosz: PC przezroczysty

*Modena LED bez
zintegrowanego klosza

Art. 351
E27, 77W Halo
EEI: A+,D

Art. 381
E27, 77W Halo
EEI: A+,D

Art. 350
E27, 77W Halo
EEI: A+,D

Art. 380
E27, 77W Halo
EEI: A+,D

Art. 351A
E27, 77W Halo
EEI: A+,D

Art. 381A
E27, 77W Halo
EEI: A+,D

Akcesoria
Narożnik Art. 152 350, 351, 380, 381 i 1200.

Art. 1200
Moduł LED 
11,3W
1100 lm
3000K, 50000h
EEI: A+

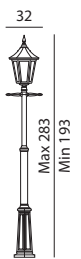

Art. 301
E27, 77W Halo
EEI: A+,D

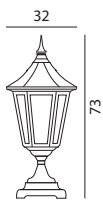

Art. 384
E27, 77W Halo
EEI: A+,D

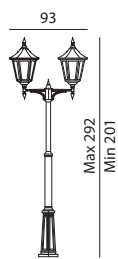

Art. 382
E27, 2x77W Halo
EEI: A+,D



Art. 304
E27, 77W Halo
EEI: A+,D

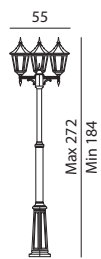

Art. 303
E27, 3x77W Halo
EEI: A+,D

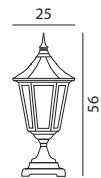

Art. 300
E27, 77W Halo
EEI: A+,D

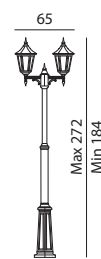

Art. 302
E27, 2x70W Halo
EEI: A+,D

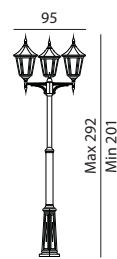

Art. 397
E27, 3x77W Halo
EEI: A+,D

Art. 1207
12W LED
EEI: A

Akcesoria

Do art. 301, 302, 303, 382 i 397

- Kotwa - 108
- Kotwa - 305
- Kotwa - 306
- Słup - 3010
- Słup - 30101

Do art. 300, 304 i 384
Kotwa - 307

*Moderna w wersji LED - dostępność oraz termin realizacji po ustaleniu z Działem Handlowym Norlys Sp. z o.o.

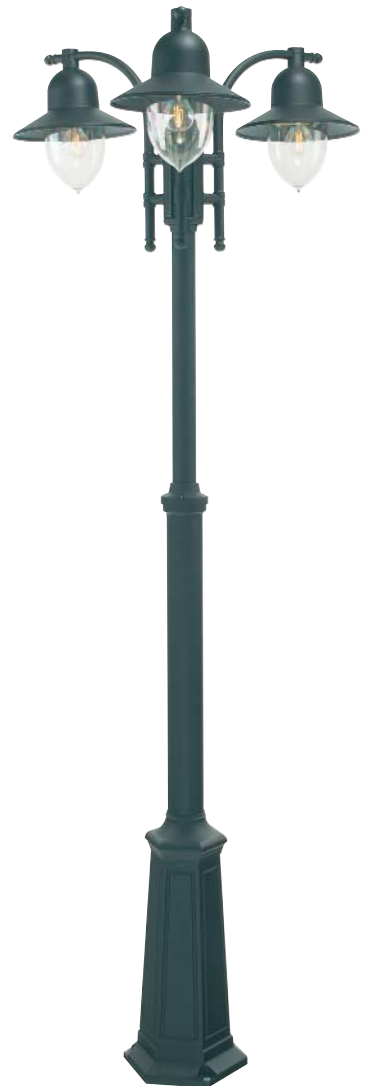
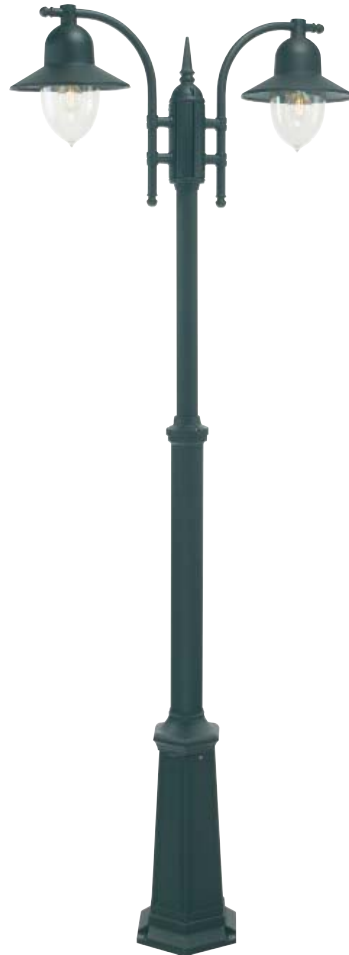

COMO



E27



Czarny Biały

*Kolory niestandardowe Norlisy za dopłatą



Grafit Zielona-patyna Miedziana-patyna

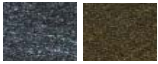

Srebrna-patyna Złota-patyna

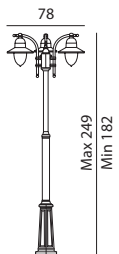
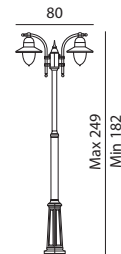
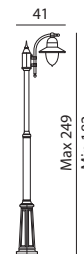
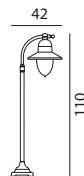
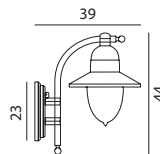

COMO
IP54, Klasa II

Oprawa: odlew
alumiiniowy malowany
proszkowo

Klosz: PC przezroczysty
(opcjonalnie możliwość
zamówienia klosza
mlecznego)

Art. 370
E27, 57W Halo
EEI: A+..D

Akcesoria
Narożnik Art. 152

Art. 375
E27, 57W Halo
EEI: A+..D

Akcesoria
Kotwa - Art. 307

Art. 371
E27, 57W Halo
EEI: A+..D

Akcesoria
Do art. 371, 372, 373

Kotwa - 108
Kotwa - 305
Kotwa - 306
Słup - 3010
Słup - 30101

Art. 372
E27, 2x57W Halo
EEI: A+..D

Art. 373
E27, 3x57W Halo
EEI: A+..D



FLORENCJA



E27



Czarny Biały

*Kolory niestandardowe Norlys za dopłatą

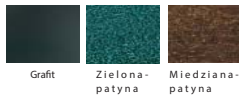

Grafit Zielona-patyna Miedziana-patyna



Srebrna-patyna Złota-patyna

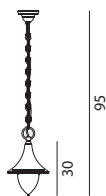

FLORENCJA
IP54, Klasa II

Oprawa: odlew
aluminiowy malowany
proszkowo

Klosz: PC przezroczysty
(opcjonalnie
możliwość zamówienia
klosza mlecznego)

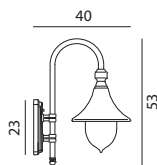

Art. 800A
E27, 57W Halo
EEI: A+..D

Art. 800
E27, 57W Halo
EEI: A+..D

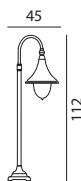

Art. 805
E27, 57W Halo
EEI: A+..D

Akcesoria
Narożnik Art. 152

Akcesoria
Kotwa - Art. 307

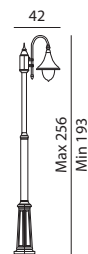

Art. 810
E27, 57W Halo
EEI: A+..D

Akcesoria
Do art. 371, 372, 373

Kotwa - 108
Kotwa - 305
Kotwa - 306
Słup - 3010
Słup - 30101

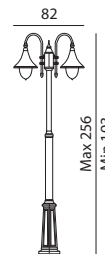

Art. 820
E27, 2x57W Halo
EEI: A+..D

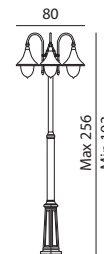

Art. 830
E27, 3x57W Halo
EEI: A+..D

Aksesoria



Art. 150
Narożnik
Rimini



Art. 152
Narożnik:
Chelsea
Bolonia
London
Modena
Como
Florencja

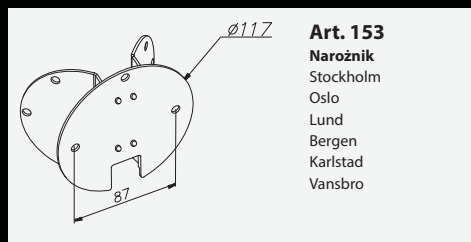

Art. 153
Narożnik
Stockholm
Oslo
Lund
Bergen
Karlstad
Vansbro

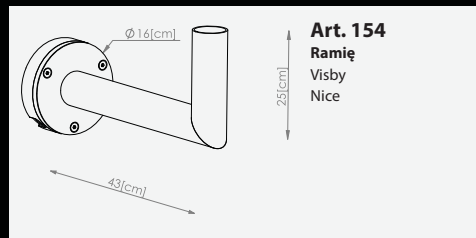

Art. 154
Ramię
Visby
Nice

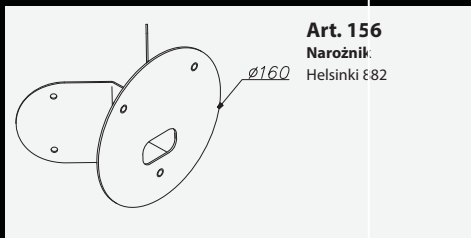

Art. 156
Narożnik:
Helsinki 82

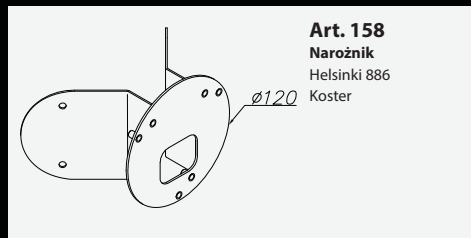

Art. 158
Narożnik
Helsinki 886
Koster

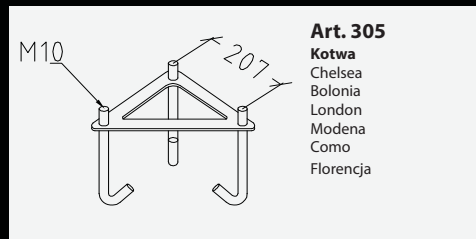

Art. 305
Kotwa
Chelsea
Bolonia
London
Modena
Como
Florencja

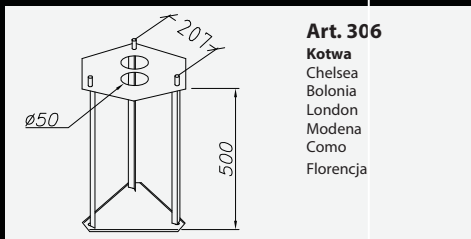

Art. 306
Kotwa
Chelsea
Bolonia
London
Modena
Como
Florencja

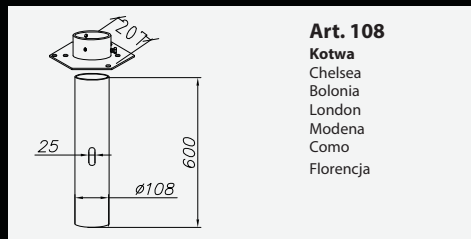

Art. 108
Kotwa
Chelsea
Bolonia
London
Modena
Como
Florencja

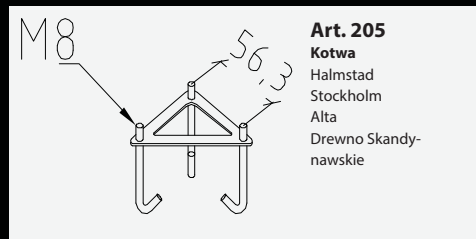

Art. 205
Kotwa
Halmstad
Stockholm
Alta
Drewno Skandy-
nawskie

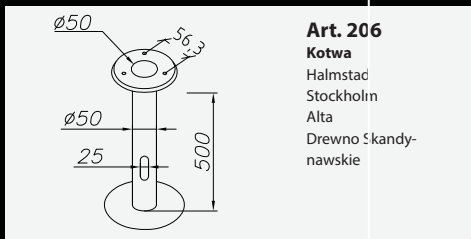

Art. 206
Kotwa
Halmstad
Stockholm
Alta
Drewno Skandy-
nawskie

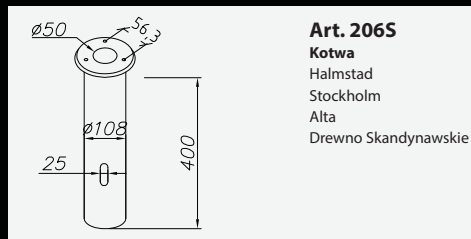

Art. 206S
Kotwa
Halmstad
Stockholm
Alta
Drewno Skandynawskie

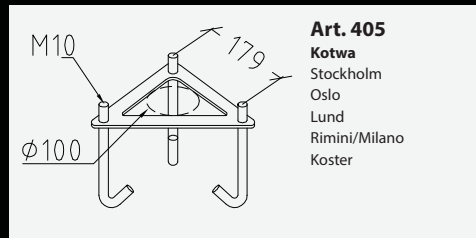

Art. 405
Kotwa
Stockholm
Oslo
Lund
Rimini/Milano
Koster

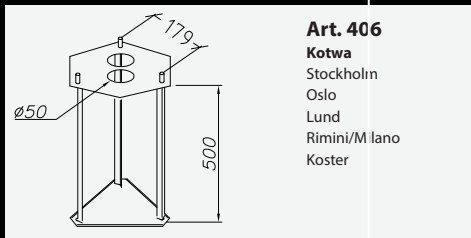

Art. 406
Kotwa
Stockholm
Oslo
Lund
Rimini/Milano
Koster

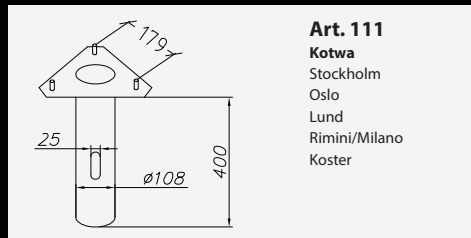

Art. 111
Kotwa
Stockholm
Oslo
Lund
Rimini/Milano
Koster

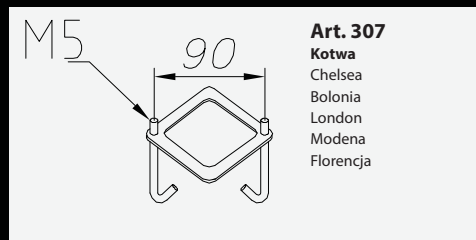

Art. 307
Kotwa
Chelsea
Bolonia
London
Modena
Florencja

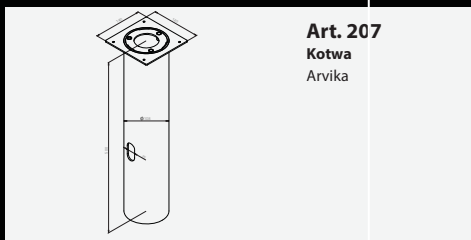

Art. 207
Kotwa
Arvika

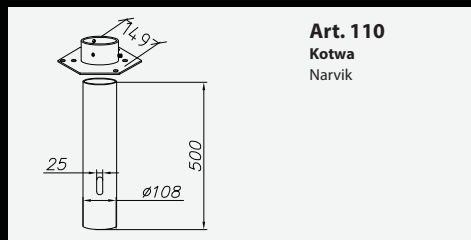

Art. 110
Kotwa
Narvik

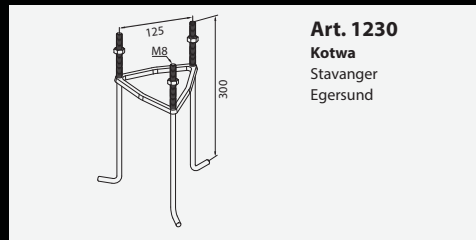

Art. 1230
Kotwa
Stavanger
Egersund

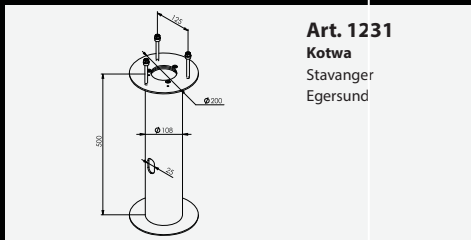

Art. 1231
Kotwa
Stavanger
Egersund

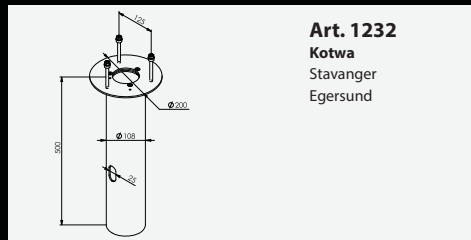

Art. 1232
Kotwa
Stavanger
Egersund

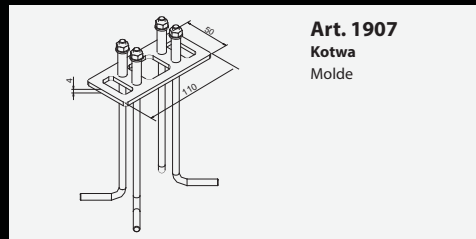

Art. 1907
Kotwa
Molde

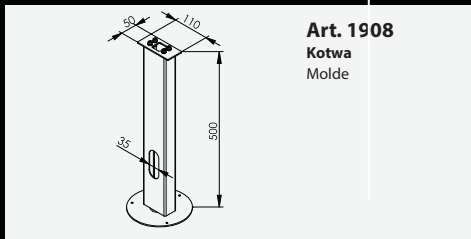

Art. 1908
Kotwa
Molde

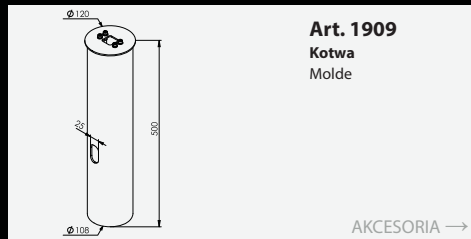

Art. 1909
Kotwa
Molde

Akcesoria



Art. 112
Kotwa
Namsos

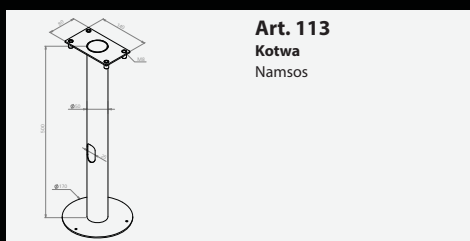

Art. 113
Kotwa
Namsos

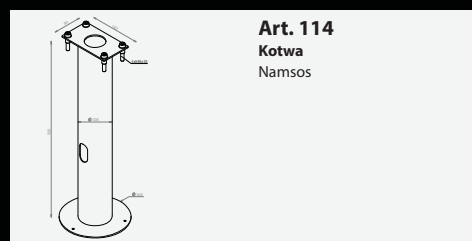

Art. 114
Kotwa
Namsos

Słup i akcesoria

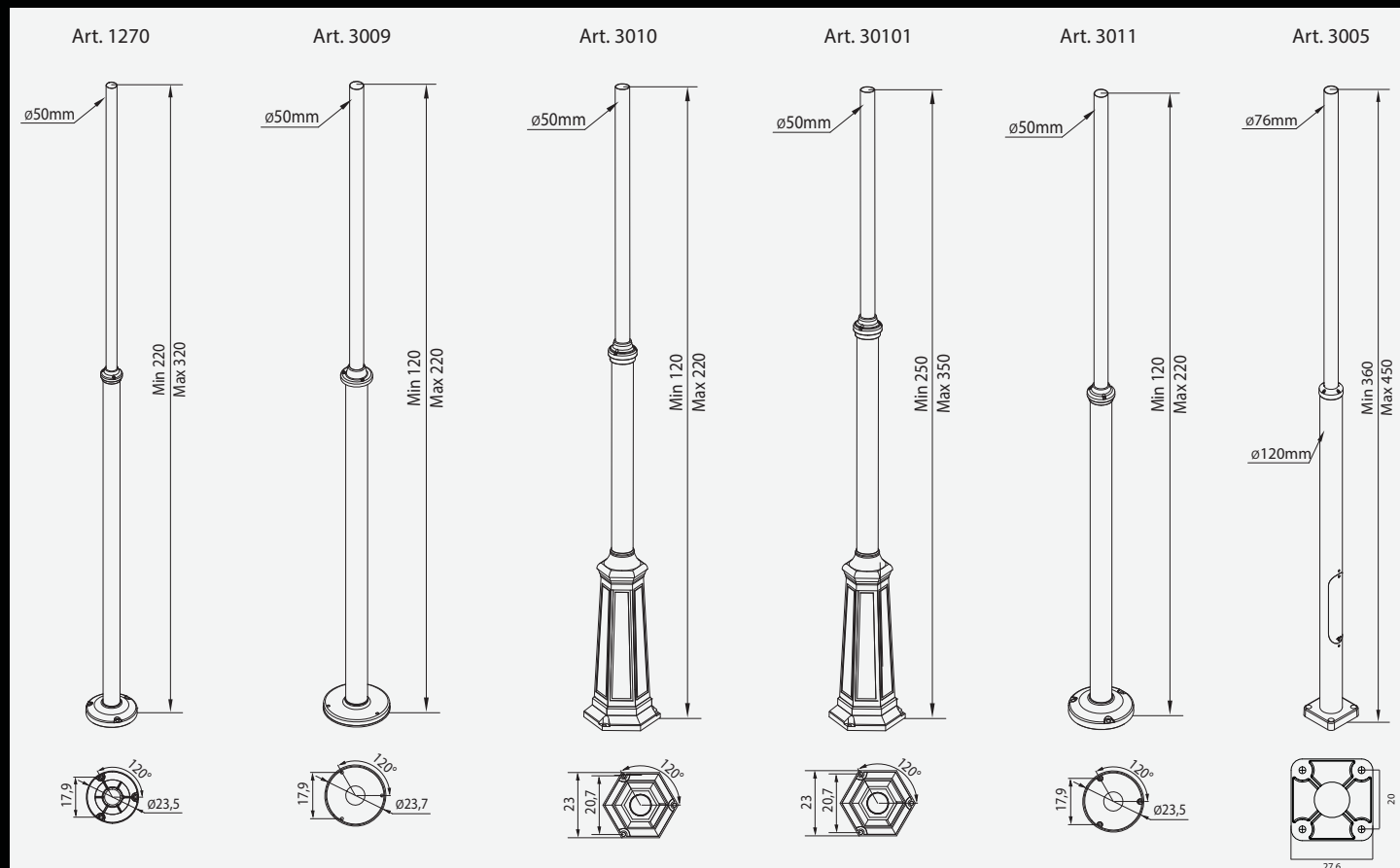

Art. 1270: Wykonany z aluminium, dla opraw malowanych

Art. 3009: Wykonany ze stali, dla opraw cynkowanych ogniowo

Art. 3010: Wykonany z aluminium, dla opraw klasycznych

Art. 30101: Wykonany z aluminium, dla opraw klasycznych

Art. 1270: Wykonany z aluminium, dla opraw malowanych

Art. 3005: Do opraw : VISBY, SUNNFJORD, NICEA i KOSTER, Do użytku publicznego, parków, parkingów.

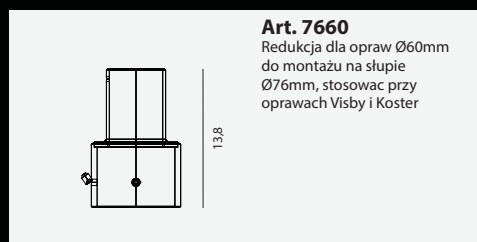

Art. 7660
Redukcja dla opraw Ø60mm do montażu na słupie Ø76mm, stosować przy oprawach Visby i Koster

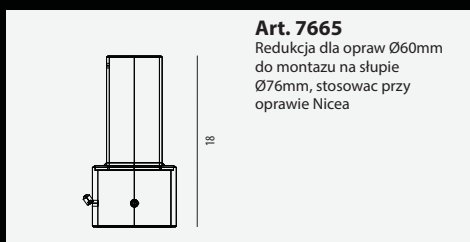

Art. 7665
Redukcja dla opraw Ø60mm do montażu na słupie Ø76mm, stosować przy oprawie Nicea

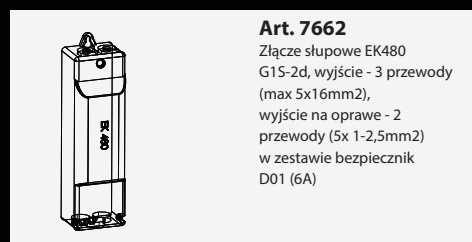

Art. 7662
Złącze słupowe EK480 G15-2d, wyjście - 3 przewody (max 5x1,6mm²), wyjście na oprawie - 2 przewody (5x 1-2,5mm²) w zestawie bezpiecznik D01 (6A)



Art. 7661
Puszka przyłączeniowa z 5-cio torowa listwa przyłączeniowa

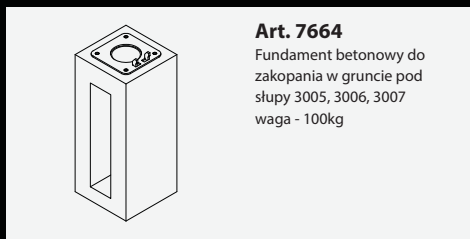

Art. 7664
Fundament betonowy do zakopania w gruncie pod słupy 3005, 3006, 3007 waga - 100kg



Art. 1509
Redukcja z osłoną dla oprawy Sunnfjord umożliwiającą montaż na słupie Ø60 mm

Źródła światła

Źródło światła

Trzonek

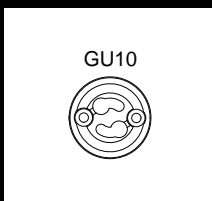
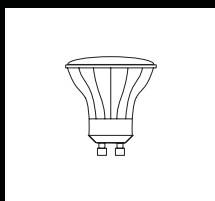
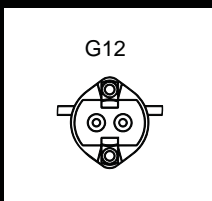
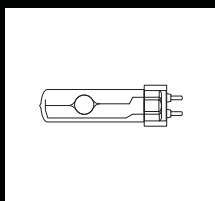
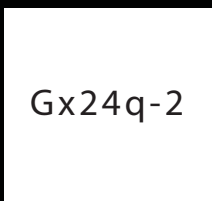
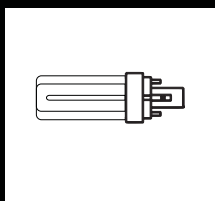
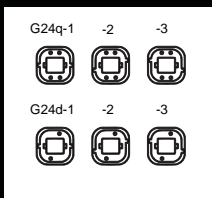
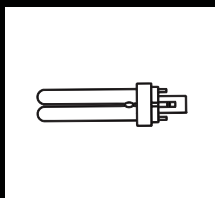
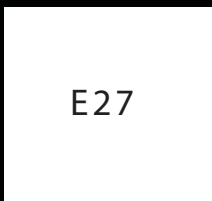
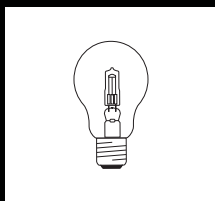

HALOGEN	GLS
30W	<=> 40W
46W	<=> 60W
57W	<=> 75W
77W	<=> 100W

Klasa energetyczna



Więcej informacji na stronie internetowej : www.norlys.pl

Produkty LED: oznaczone znakiem

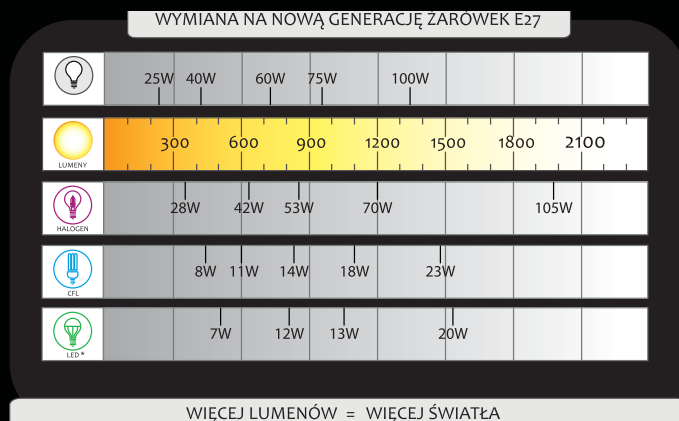

Kolory

Aluminium, RAL 9006

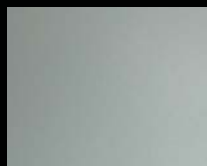

Grafit, RAL 7016



Biały, RAL 9003



Czarny, RAL 9005

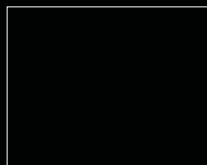

Stal kortenowa



Złota patyna



Zielona Patyna



Miedziana patyna



Srebrna patyna



Stal galwaniczna



Stal nierdzewna



Miedź

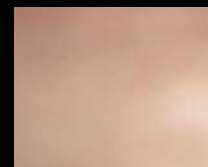

Patyna dostępna tylko dla koloru czarnego i za dopłatą 5%.

Kolory oznaczone jako niestandardowe za dopłatą 10% oraz z wydłużonym terminem realizacji.

Na życzenie klienta możemy lakierować proszkowo oprawy na dowolny kolor z palety RAL według indywidualnej kalkulacji.

Kolory produkowanych opraw mogą się nieznacznie różnić od tych przedstawionych w niniejszym katalogu.

Barwa światła (Kelvin)



Nowości - Oprawy dostępne w sprzedaży od stycznia 2017

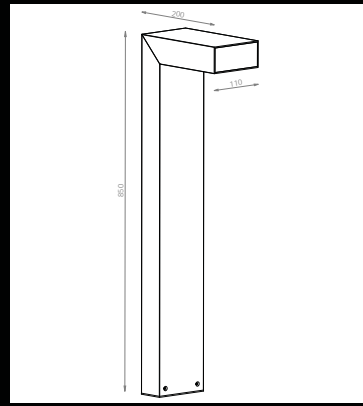

Asker

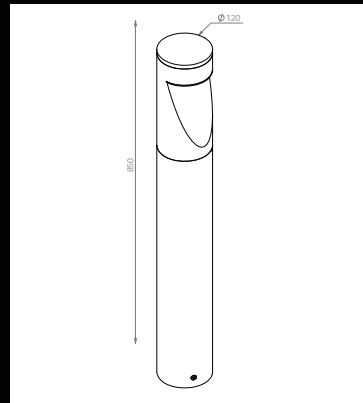

Oppland

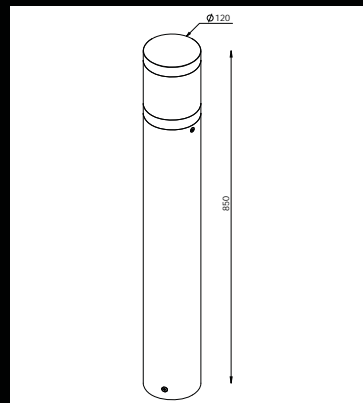

Egerund mini

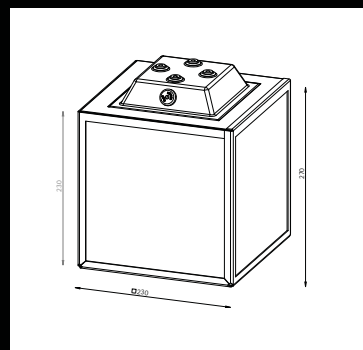

Lofoten

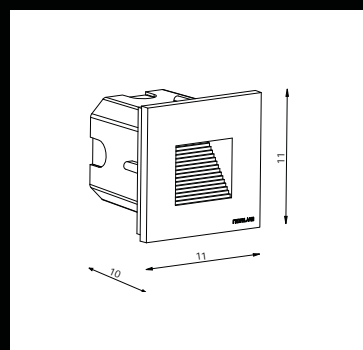

Namsos mini

Oprawy zawarte w katalogu dostępne u Dystrybutorów.



Norlys Sp. zo.o.
ul. Zawiszy Czarnego 7
33-300 Nowy Sacz
tel. (18) 444-21-11
www.norlys.pl

