





Norlys to skandynawska firma z ponad sześćdziesięcioletnią tradycją w zakresie produkcji oświetlenia zewnętrznego. Tworzymy oprawy proste, a jednocześnie o najwyższych walorach estetycznych, zgodnych z aktualnymi trendami, o jakości spełniającej wymagania nawet najbardziej wymagających Klientów na całym świecie.

Nie mamy tajemnic: Nasza jakość to wynik właściwego doboru materiałów produkcyjnych i profesjonalnego zarządzania procesem produkcyjnym. Wszystkie nasze produkty wytwarzane są na terenie Europy zgodnie z ISO 9001. W zakładzie produkcyjnym o powierzchni ponad 15000 m² wykorzystujemy innowacyjny park maszynowy. Nasza odlewnia jest jedną z najnowocześniejszych tego typu w Europie. Stałe inwestycje na terenie zakładu pozwalają nam utrzymać procesy produkcyjne na najwyższym poziomie.

Kiedy nie możemy czegoś wykonać sami, starannie dobieramy naszych partnerów. Jest to szczególnie ważne w przypadku stosowania najnowocześniejszej technologii LED. Zawsze współpracujemy z najlepszymi i sprawdzonymi dostawcami.

Design, szeroki asortyment, doskonała jakość to parametry które cechują nasze oprawy. Tam gdzie liczy się czas, wyjątkowo ważnym aspektem staje się termin realizacji zamówień. Dlatego posiadamy kilkanaście magazynów produktów gotowych do wysyłki. Jeśli aktualnie określonego produktu nie ma na stanie, produkujemy go w ciągu kilku dni.

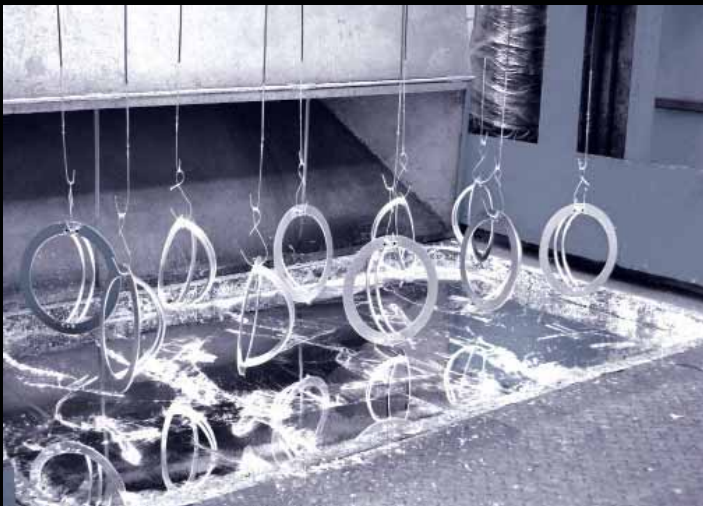

Zdjęcia zamieszczone w tym katalogu nie mogą być kopiowane bez zgody Norlys Sp. z o.o.
Zastrzegamy sobie prawo do zmian charakterystyk modeli bez uprzedzenia i bez obowiązku powiadomienia,
w zależności od własnych wymagań technicznych i/ lub w celu ulepszenia parametrów produktów.

INDEKS



ALTA
s. 50



ARENDAL
s. 48



ARVIKA
s. 16



ASKER RODZINA
s. 28, 29, 30, 31



BAZYLEA
s. 42, 43



BERGEN RODZINA
s. 63



BERLIN
s. 56



BERNO
s. 42



BODEN
s. 34



BOLONIA RODZINA
s. 70, 71



BORNHOLM
s. 57



BREMEN
s. 56



CHELSEA RODZINA
s. 64, 65



COMO RODZINA
s. 78



EGERSUND RODZINA
s. 10, 11



FLORENCJA RODZINA
s. 79

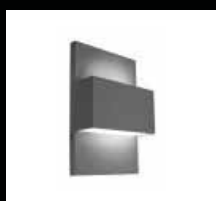

GENEVA
s. 39



GENUA
s. 68



GENUA MINI
s. 68



GLASGOW
s. 69



GRIMSTAD RODZINA
s. 23



HALDEN
s. 40



HALMSTAD RODZINA
s. 49



HELSINKI RODZINA
s. 19



HITRA
s. 26, 27



KARLSTAD
s. 62



KIRUNA
s. 19



KOSTER RODZINA
s. 15



LARVIK
s. 59



LATINA
s. 68



LILLEHAMMER
s. 32, 33



LILLESAND
s. 44



LOFOTEN RODZINA
s. 66, 67



LONDON RODZINA
s. 72, 73, 74, 75



LUND RODZINA
s. 60

INDEKS



MANDAL
s. 38

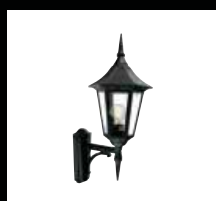

MODENA RODZINA
s. 76, 77



MOLDE
s. 46, 47



NAMSOS RODZINA
s. 24, 25



NARVIK
s. 14



NICE
s. 61



NORDKAPP
s. 35



NORDLAND
s. 35

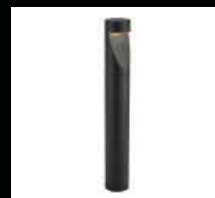

OPPLAND
s. 45



OSLO RODZINA
s. 58, 59



PARIS
s. 61



RENA
s. 20, 21



RIMINI/MILANO RODZINA
s. 80



RONDANE
s. 57



SANDE RODZINA
s. 22



STAVANGER
s. 36, 37



SKANDYNAWSKIE DREWNO
s. 51



SKI
s. 16, 17



STAVANGER RODZINA
s. 12, 13



STOCKHOLM RODZINA
s. 52, 53, 54, 55



SUNNFJORD
s. 7



TORINO
s. 69



VANSBRO
s. 63



VASA
s. 40, 41



VISBY
s. 8, 9



VOSS
s. 18



AKCESORIA/INFO
s. 81, 82, 83



NICEA



LED



Aluminium

Grafit

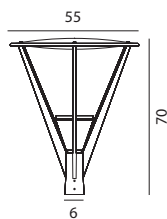

NICEA
IP65, Klasa I
Do słupa o średnicy zewnętrznej
ø60 mm na szczycie.

Akcesoria
Słup - Art. 3004, 3005, 3006, 3007:
Możliwość dokupienia słupa
wraz z redukcją.
(Strona 83)

Art. 154: Konsola z
ramieniem od Nicea.
(Strona 82)

Art. 777 
40,3W
Aluminium, 777AL
Grafit, 777GR
Moduł LED: 5127 lm,
3000K, >50 000h, EEL: A++

* Wersja 4000K i/lub DALI
- dostępność oraz termin
realizacji po ustaleniu z
Działem Handlowym Norlys
Sp. z o.o.



SUNNFJORD



LED



Aluminium

Grafit

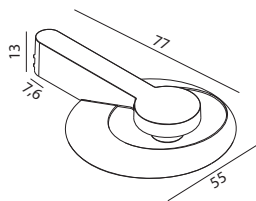

SUNNFJORD

IP55, Klasa I

Do słupa o średnicy zewnętrznej $\varnothing 76$ mm na szczycie.

Akcesoria

Słup - Art. 3004, 3005, 3006, 3007:

Możliwość dokupienia słupa wraz z redukcją.

(Strona 83)

Redukcja - Art.1509

Redukcja z osłoną dla oprawy Sunnfjord umożliwiającą montaż na słupie $\varnothing 60$ mm.

(Strona 83)

Art. 1507

46,7W



Aluminium, 1507AL

Grafit, 1507GR

Moduł LED: 6000 lm,
4000K, >60 000h, EEL: A++

Art. 1508

31,5W



Aluminium, 1508AL

Grafit, 1508GR

Moduł LED: 4342 lm,
4000K, >60 000h, EEL: A++



Wersja LED

VISBY

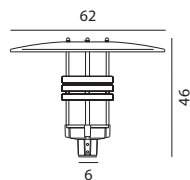
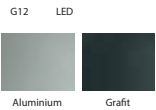

VISBY
IP65, Klasa I
Do użycia ze słupami bądź konsolą
o średnicy zewnętrznej $\varnothing 60$ mm.

Akcesoria
Słup - Art. 3004, 3005, 3006, 3007:
Możliwość dokupienia słupa
wraz z redukcją.
(Strona 83)

Art. 154: Konsola z
ramieniem od Visby.
(Strona 82)

Art. 575
70W HIT-CE, G12
Aluminium, 575AL
Grafit, 575GR
EEI: A+



Art. 576 
44,5W
Aluminium, 576AL
Grafit, 576GR

Moduł LED (górze): 2950 lm,
3000K, >50 000h, EEI: A+

Moduł LED (dół): 1950 lm,
3000K, >50 000h, EEI: A+

Wersja wyposażona w 2 moduły
LED – jeden moduł świecący
bezpośrednio w dół, światło
drugiego odbite od daszka.



Art. 577 
27W
Aluminium, 577AL
Grafit, 577GR

Moduł LED (górze): 2950 lm,
3000K, >50 000h, EEI: A+

Wersja wyposażona w moduł
LED - światło pośrednie skierowane
w dół.

* Wersja 4000K i/lub DALI -
dostępność oraz termin realizacji
po ustaleniu z Działem Handlowym
Norllys Sp. z o.o.



EGERSUND MINI

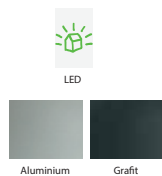

EGERSUND

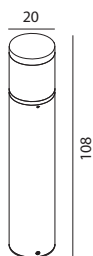
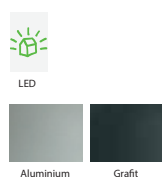

EGERSUND
IP65, Klasa I

Oprawa:
odlew aluminiowy
malowany proszkowo.

Klosz: PC
przeźroczysty.

Aksesoria
Do art. 1280 i 1285
Kotwa - Art. 1230
Kotwa - Art. 1231
Kotwa - Art. 1232

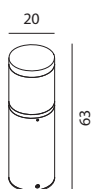

Art. 1280
20,3W
Aluminium, 1280AL
Grafit, 1280GR
Moduł LED : 2240 lm,
3000K, >50 000h, EEI: A+

Art. 1285
20,3W
Aluminium, 1285AL
Grafit, 1285GR
Moduł LED : 2240 lm,
3000K, >50 000h, EEI: A+

* Wersja 4000K i/lub DALI - dostępność oraz termin realizacji
po ustaleniu z Działem Handlowym Norlys Sp. z o.o.

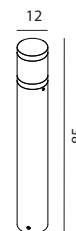

EGERSUND MINI
IP65, Klasa I

Oprawa:
odlew aluminiowy
malowany proszkowo.

Klosz: PC
przeźroczysty.

Aksesoria
Do art. 1290 i 1291
Kotwa - Art. 205
Kotwa - Art. 206
Kotwa - Art. 206S

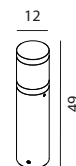

Art. 1290
13,2W
Aluminium, 1290AL
Grafit, 1290GR
Moduł LED : 1360 lm,
3000K, >50 000h,
ściemnialny, EEI: A+

Art. 1291
13,2W
Aluminium, 1291AL
Grafit, 1291GR
Moduł LED : 1360 lm,
3000K, >50 000h,
ściemnialny, EEI: A+





STAVANGER



LED



Aluminium

Grafit



Klosz satynowany

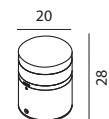
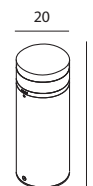
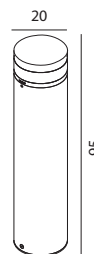

STAVANGER

IP65, Klasa I
Oprawa: odlew aluminiowy
malowany proszkowo.

Art. 1240, 1244, 1247:
Klosz: PC przezroczysty
Odporność: IK10.

Art. 1243, 1246, 1248:
Klosz: PMMA satynowany.

Akcesoria

Kotwa - Art. 1230
Kotwa - Art. 1231
Kotwa - Art. 1232

Art. 1240

17,5W 
Aluminium, 1240AL
Grafit, 1240GR
Moduł LED: 1380 lm,
3000K, >50 000h, EE: A+

* Wersja 4000K i/lub DALI - dostępność oraz termin realizacji po ustaleniu z Działem Handlowym Norlys Sp. z o.o.

Art. 1243

E27, 46W Halo
Aluminium, 1243AL
Grafit, 1243GR
EE: A+..D

Art. 1244

17,5W 
Aluminium, 1244AL
Grafit, 1244GR
Moduł LED: 1380 lm,
3000K, >50 000h, EE: A+

Art. 1246

E27, 46W Halo
Aluminium, 1246AL
Grafit, 1246GR
EE: A+..D

Art. 1247

9,2W 
Aluminium, 1247AL
Grafit, 1247GR
Moduł LED: 750 lm,
3000K, >50 000h, EE: A+

Art. 1248

E27, 46W Halo
Aluminium, 1248AL
Grafit, 1248GR
EE: A+..D





NARVIK



LED



Aluminium

Grafit

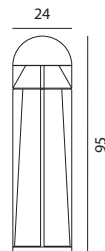

NARVIK
IP65, Klasa I
Odporność: IK10

Oprawa: odlew aluminiowy
malowany proszkowo.

Klosz: PC przezroczysty.

Art. 557 
24,6W
Aluminium, 557AL
Grafit, 557GR
Moduł LED : 3137 lm,
3000K, >50 000h, EEI: A++

Akcesoria
Kotwa - Art. 110

* Wersja 4000K i/lub DALI
- dostępność oraz termin
realizacji po ustaleniu z Działem
Handlowym Norlys Sp. z o.o.

KOSTER

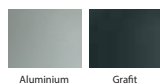

ART. 720, 1911



ART. 724, 725, 1912



ART. 1913



ART. 1914

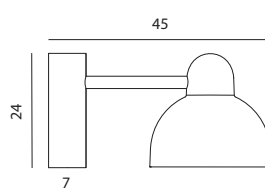
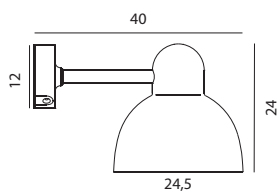
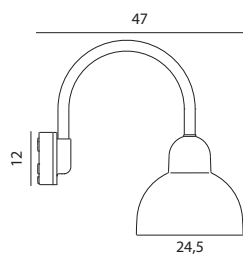

Koster Rodzina
IP54
Klosz:
PC struktura.

Koster Kinkiet
Art. 720
Klasa II
E27, 77W Halo
Aluminium, 720AL
Grafit, 720GR
EEI: A+,D

Koster Kinkiet
Art. 724
Klasa I
E27, 77W Halo
Aluminium, 724AL
Grafit, 724GR
EEI: A+,D

Koster Kinkiet
Art. 1912
Klasa I
17,5W
Aluminium, 1912AL
Grafit, 1912GR
Moduł LED : 1950 lm,
3000K, >50 000h, EEI: A+

Koster głowa
Art. 1913
Klasa I
17,5W
Aluminium, 1913AL
Grafit, 1913GR
Moduł LED : 1950 lm,
3000K, >50 000h, EEI: A+

Koster słupek teleskopowy
Art. 1914
Klasa I
17,5W
Aluminium, 1914AL
Grafit, 1914GR
Moduł LED : 1950 lm,
3000K, >50 000h, EEI: A+

Art. 1911
Klasa I
17,5W
Aluminium, 1911AL
Grafit, 1911GR
Moduł LED : 1950 lm,
3000K, >50 000h, EEI: A+

Art. 725
Klasa I
9,5W
Aluminium, 725AL
Grafit, 725GR
Moduł LED : 1080 lm,
3000K, >50 000h, EEI: A+

Akcesoria
Narożnik Art. 158
Do Art: 720, 724, 725,
1911, 1912

* Art. 1913: Do słupów
o średnicy $\phi 60$ mm
na szczycie

Akcesoria
Art. 3005
Do Art. : 1913

Akcesoria
For Art: 1914
Kotwa - 111
Kotwa - 405
Kotwa - 406

* Wersja 4000K - dostępność oraz termin realizacji po ustaleniu z Działem Handlowym Norlys Sp. z o.o.

SKI

NOWOŚĆ



LED



O cynk

Czarny



ARVIKA

NOWOŚĆ



E27



LED



O cynk

Czarny

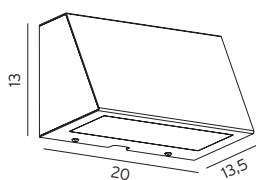
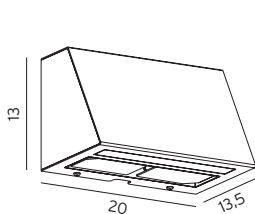

SKI
IP44, Klasa I

Oprawa: stal cynkowa
ogniowo i malowana
proszkowo w standardzie.

Klosz: PC struktura.

SKI **Art. 1390 (Dystrybutor)**
5,2W
O cynk, 1390GA
Czarny, 1390B
Moduł LED : 628 lm, 3000K,
>70 000h, ściemniający, EEI: A+

SKI **Art. 1392**
5,2W
O cynk, 1392GA
Czarny, 1392B
Moduł LED : 628 lm, 3000K,
>70 000h, ściemniający, EEI: A+

ARVIKA
IP44, Klasa I
Oprawa: stal cynkowa
ogniowo i malowana
proszkowo w standardzie.

Klosz: PC przezroczysty.

Akcesoria
Kotwa - Art. 207

ARVIKA **Art. 891**
11,3W
O cynk, 891GA
Czarny, 891B
Moduł LED : 1120 lm,
3000K, >50 000h, EEI: A+

Art. 893 (Dystrybutor)
11,3W
O cynk, 893GA
Czarny, 893B
Moduł LED : 1120 lm,
3000K, >50 000h, EEI: A+

ARVIKA
Art. 898
E27, 46W Halo
O cynk, 898GA
Czarny, 898B
EEI: A+-D

Art. 899 (Dystrybutor)
E27, 46W Halo
O cynk, 899GA
Czarny, 899B
EEI: A+-D





VOSS

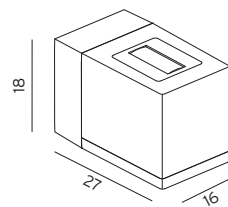
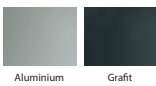

VOSS
IP54, Klasa I
Klosz: szkło bezpieczne
przeźroczyste.

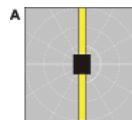

(Wersje. A)
Art. 783
70W, G12
Aluminium, 783AL
Grafit, 783GR
EEL: A+

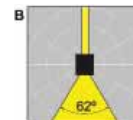

(Wersje. B)
Art. 780
70W, G12
Aluminium, 780AL
Grafit, 780GR
EEL: A+

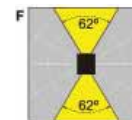

(Wersje. F)
Art. 784
70W, G12
Aluminium, 784AL
Grafit, 784GR
EEL: A+

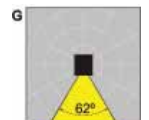

(Wersje. G)
Art. 785
70W, G12
Aluminium, 785AL
Grafit, 785GR
EEL: A+

Art. 1950 
20,8W
Aluminium, 1950AL
Grafit, 1950GR
Moduł LED : 1830 lm,
3000K, >50 000h, EEL: A+

Art. 1951 
14,9W
Aluminium, 1951AL
Grafit, 1951GR
Moduł LED : 1220 lm,
3000K, >50 000h, EEL: A+

HELSINKI



E27



Aluminium

Grafit



KIRUNA

NOWOŚĆ



LED

E27



Aluminium

Grafit

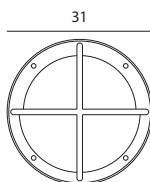

31

głębokość 21

KIRUNA

Odporność: IK10
Klosz: PC mleczny.

Wandaloodporna,
4 mm klosz z poliwęglanu.

Klasa I: Art. 596

Klasa II: Art. 597, 598

NOWOŚĆ

KIRUNA Art. 596

Klasa I
17,5W
Aluminium, 596AL
Grafit, 596GR
Moduł LED: 1950 lm,
3000K, >50 000h, EEL: A+



KIRUNA Art. 597

klasa II
E27, 46W Halo
Aluminium, 597AL
Grafit, 597GR
EEL: A+,D

Art. 598

klasa II
E27, 46W Halo
Aluminium, 597AL
Grafit, 597GR
EEL: A+,D

HELSINKI

IP54

Klasa II: Art. 882

Klasa I: 886

Oprawa: odlew
alumiowy malowany
proszkowo.

Klosz: PC

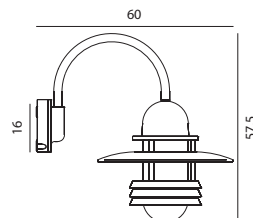

60

16

57,5

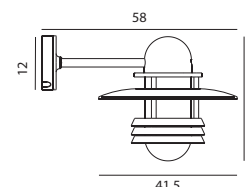

58

12

37

41,5

HELSINKI

klasa II

Art. 882
E27, 77W Halo
Aluminium, 882AL
Grafit, 882GR
EEL: A+,D

Akcesoria

Narożnik Art. 156

HELSINKI

klasa I

Art. 886
E27, 77W Halo
Aluminium, 886AL
Grafit, 886GR
EEL: A+,D

Akcesoria

Narożnik Art. 158



RENA

NOWOŚĆ



GU10
LED



Czarny

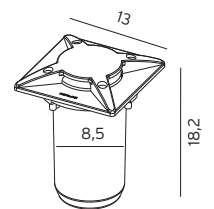
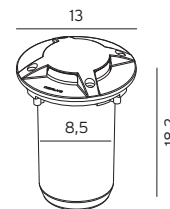

Rena

IP68(1m), Klasa I

Korpus: odlew aluminiowy malowany proszkowo.

Puszka: polipropylen.

Front: odlew aluminiowy.

Klosz: PC przezroczysty lub satynowany.

Oprawa oświetleniowa do montażu w podłożu, korpus i pokrywa - odlew aluminiowy malowany proszkowo, 3 metrowy przewód zasilający. (PG ze stali nierdzewnej dla przewodu 8-12 mm). Puszka montażowa z polipropylenu w zestawie.

Art 1630 oraz 1632: bez przewodu zasilającego, źródła światła, dwie dławnice.

Art. 1631 oraz 1633: 3 metrowy przewód zasilający, jedna dławnica, dołączone źródło światła LED 5,5W GU10, 375lm, 3000K, 36D.

Art. 1630

Okrągła

6W max., GU 10

Czarny, 1630B

EEI: A+..D

Art. 1631

Okrągła

5,5W

Czarny, 1631B

Zawiera 5,5W LED, GU10, 375 lm, 3000K, 40000h, 36D, ściemniający
EEI: A+



Art. 1632

Kwadratowa

6W max., GU 10

Czarny, 1632B

EEI: A+..D

Art. 1633

Kwadratowa

5,5W

Czarny, 1633B

Zawiera 5,5W LED, GU10, 375 lm, 3000K, 40000h, 36D, ściemniający
EEI: A+



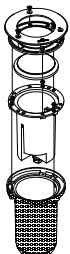

Rena

IP68(1m), Klasa I

Korpus: odlew aluminiowy malowany proszkowo.

Puszka: polipropylen.

Front: nierdzewna stal szlachetna.

Klosz: szkło hartowane, przezroczyste lub satynowane.

Oprawa oświetleniowa do montażu w podłożu, korpus z odlewu aluminium malowany proszkowo, pokrywa ze stali nierdzewnej 316L, szkło bezpieczne (max. 2000 kg), 3 metrowy przewód zasilający. (PG ze stali nierdzewnej dla przewodu 8-12 mm). Puszka montażowa z polipropylenu w zestawie.

Art. 1550, 1551, 1554, 1555: 3 metrowy przewód zasilający, jedna dławnica, dołączone źródło światła LED 5,5W GU10, 375lm, 3000K, 36D.

Art. 1552, 1553, 1556, 1557: bez przewodu zasilającego, źródła światła, dwie dławnice.

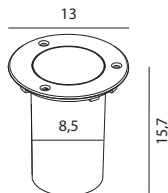

Art. 1550

Okrągła

Klosz: przezroczysty

5,5W

Stal nierdzewna, 1550ST
Zawiera 5,5W LED, GU10, 375 lm,
3000K, 40000h, 36D, ściemniający
EEI: A+

Art. 1552

Okrągła

Klosz: przezroczysty

6W max., GU 10

Stal nierdzewna, 1552ST

EEI: A+..D

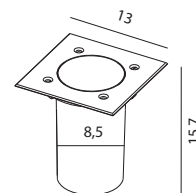

Art. 1551

Kwadratowa

Klosz: przezroczysty

5,5W

Stal nierdzewna, 1551ST
Zawiera 5,5W LED, GU10, 375 lm,
3000K, 40000h, 36D, ściemniający
EEI: A+

Art. 1553

Kwadratowa

Klosz: przezroczysty

6W max., GU 10

Stal nierdzewna, 1553ST

EEI: A+..D

Art. 1555

Kwadratowa

Klosz: satynowany

5,5W

Stal nierdzewna, 1555ST
Zawiera 5,5W LED, GU10, 375 lm,
3000K, 40000h, 36D, ściemniający
EEI: A+

Art. 1557

Kwadratowa

Klosz: satynowany

6W max., GU 10

Stal nierdzewna, 1557ST

EEI: A+..D



SANDE

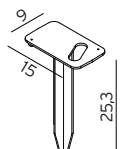
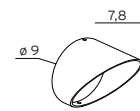
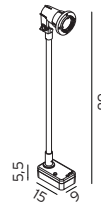
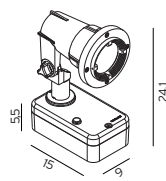
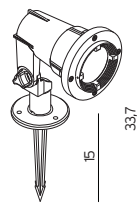
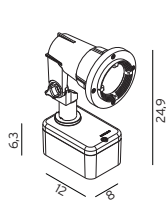
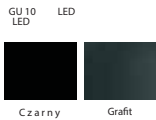



SANDE
IP65, Klasa I

Oprawa: odlew aluminiowy malowany proszkowo.

Klosz: szkło bezpieczne przezroczyste lub satynowane.

Art. 1590 
(ścienna)
5,5W
Grafit, 1590GR
Czarny, 1590B
Zawiera 5,5W LED, GU10,
375 lm, 3000K, 40000h, 36D,
ściemniálny, EEI: A+

Art. 1591 
(ścienna)
8,6W
Grafit, 1591GR
Czarny, 1591B
Moduł LED: 750 lm, 40d
3000K, >50 000h, EEI: A+

Art. 1592 
(ścienna/ ziemna)
5,5W
Grafit, 1592GR
Czarny, 1592B
Zawiera 5,5W LED, GU10, 375 lm,
3000K, 40000h, 36D, ściemniálny,
EEI: A+

Art. 1593 
(ścienna/ ziemna)
Grafit, 1593GR
Czarny, 1593B
Moduł LED: 750 lm, 40d
3000K, >50 000h, EEI: A+

* z 5- ciometrowym przewodem oraz grottem. Do montażu ściennego należy usunąć grot

Art. 1594 
(ziemna)
8,6W
Grafit, 1594GR
Czarny, 1594B
Moduł LED: 750 lm, 40d
3000K, >50 000h, EEI: A+

Art. 1598 
(ziemna)
5,5W
Grafit, 1598GR
Czarny, 1598B
Zawiera 5,5W LED, GU10, 375 lm,
3000K, 40000h, 36D, ściemniálny,
EEI: A+

Art. 1596 
(ziemna)
8,6W
Grafit, 1596GR
Czarny, 1596B
Moduł LED: 750 lm, 40d
3000K, >50 000h, EEI: A+

Art. 1599 
(ziemna)
5,5W
Grafit, 1599GR
Czarny, 1599B
Zawiera 5,5W LED, GU10, 375 lm,
3000K, 40000h, 36D, ściemniálny,
EEI: A+

Akcesoria
Przysłona - 1233

Akcesoria
Kotwa - 1234
For Art:
Art. 1594
Art. 1596
Art. 1598
Art. 1599



GRIMSTAD



LED E14



Aluminium Grafit

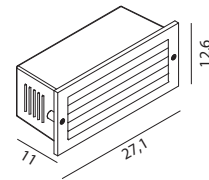
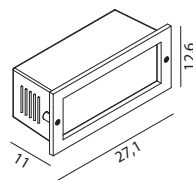

GRIMSTAD IP65, Klasa I

Korpus: odlew aluminiowy
malowany proszkowo.

Puszka montażowa:
polipropylen.

Klosz: szkło mleczne.

Art. 1544 
6W
Aluminium, 1544AL
Grafit, 1544GR
Moduł LED: 628 lm,
3000K, >70 000h, EEL: A++

Art. 1546
E14, 46W Halo
Aluminium, 1546AL
Grafit, 1546GR
EEL: A+.D

Art. 1545 
8,9W
Aluminium, 1545AL
Grafit, 1545GR
Moduł LED: 981 lm,
3000K, >60 000h, EEL: A++

Art. 1547
E14, 46W Halo
Aluminium, 1547AL
Grafit, 1547GR
EEL: A+.D

* Wersja 4000K - dostępność oraz
termin realizacji po ustaleniu z
Działem Handlowym Norlyks
Sp. z o.o.

NAMSOS



LED



Aluminium Grafit



NAMSOS

NOWOŚĆ



LED



Ocynk

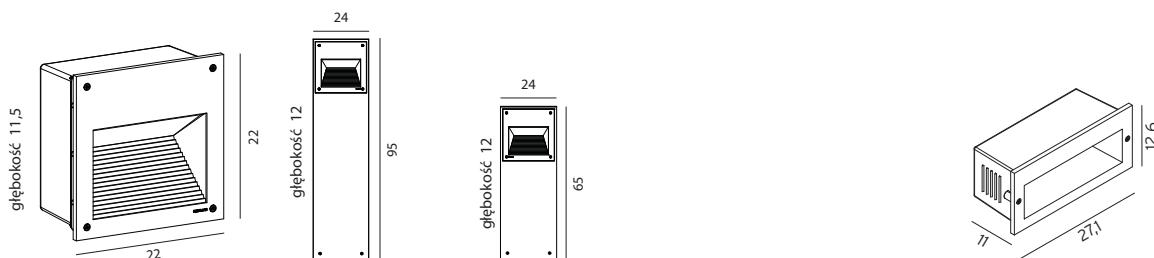

NAMSOS
IP65, Klasa I

Korpus: odlew aluminiowy malowany proszkowo.

Puszka montażowa: polipropylen.

Klosz: szkło satynowane.

Art. 1930
12,7W
Aluminium, 1930AL
Grafit, 1930GR
Moduł LED : 1376 lm,
3000K, >60 000h, EE: A++

Art. 1931
12,7W
Aluminium, 1931AL
Grafit, 1931GR
Moduł LED : 1376 lm,
3000K, >60 000h, EE: A++

Akcesoria
Do art. 1931 i 1932
Kotwa - 112
Kotwa - 113
Kotwa - 114

Art. 1932
12,7W
Aluminium, 1932AL
Grafit, 1932GR
Moduł LED : 1376 lm,
3000K, >60 000h, EE: A++

NAMSOS
IP44, Klasa I

Korpus: odlew aluminiowy malowany proszkowo.

Front: stal cynkowa ognioowo.

Puszka montażowa: polipropylen.

Klosz: szkło satynowane.

Art. 1933
5,2W
Ocynk, 1933GA
Moduł LED : 628 lm, 3000K,
>70 000h, ściemniany, EE: A++

NOWOŚĆ



NAMSOS MINI



LED



Aluminium Grafit Biały

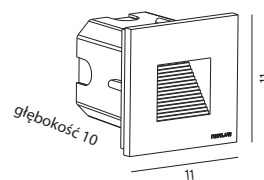

NAMSOS MINI
IP65, Klasa I

Korpus: odlew aluminiowy
malowany proszkowo.

Puszka montażowa:
polipropylen.

Klosz: szkło satynowane.

Art. 1340 
4W

Aluminium, 1340AL

Grafit, 1340GR

Biały, 1340W

Moduł LED : 351 lm, 3000K,
>50 000h, ściemniany, EEL: A



HITRA

NOWOŚĆ



LED



Aluminium



Grafit



Biały

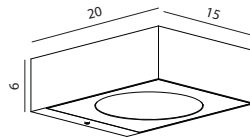

HITRA
IP65, klasa I

Oprawa: odlew
alumiowy malowany
proszkowo.

Klosz: szkło bezpieczne.

Art. 1330 
9,5W
Aluminium, 1330AL
Grafit, 1330GR
Biały, 1330W
Moduł LED: 1080 lm,
3000K, >50 000h, EEL: A+



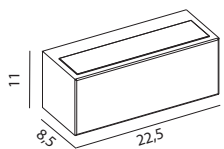

ASKER

IP65, Klasa I

Oprawa: odlew aluminiowy malowany proszkowo.
Klosz: PC struktura.

Dla uzyskania optymalnej efektywności świecenia zalecamy wersję LED.

*Uwaga: Nie obracać tylnej płyty.



Art. 1510

8W

Aluminium, 1510AL
Grafit, 1510GR
Biały, 1510W
Czarny, 1510B

Moduł LED : 978 lm, 3000K,
>50 000h, ściemniany, EEL: A+

Art. 1513

E27, 46W Halo
Aluminium, 1513AL
Grafit, 1513GR
Biały, 1513W
Czarny, 1513B
EEL: A+..D



Art. 1511

8W

Aluminium, 1511AL
Grafit, 1511GR
Biały, 1511W
Czarny, 1511B

Moduł LED : 978 lm, 3000K,
>50 000h, ściemniany, EEL: A+

Art. 1514

E27, 46W Halo
Aluminium, 1514AL
Grafit, 1514GR
Biały, 1514W
Czarny, 1514B
EEL: A+..D

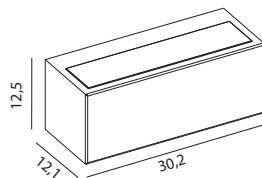

ASKER (big)

IP65, Klasa I

Oprawa: odlew aluminiowy malowany proszkowo.
Klosz: PC struktura.

Dla uzyskania optymalnej efektywności świecenia zalecamy wersję LED.

*Wersja 4000K - dostępność oraz termin realizacji po ustaleniu z Działem Handlowym Norlys Sp. z o.o.

*Uwaga: Nie obracać tylnej płyty.



Art. 1300

9,3W

Aluminium, 1300AL
Grafit, 1300GR
Biały, 1300W
Czarny, 1300B
Moduł LED : 2x628 lm,
3000K, >70 000h, EEL: A+

Art. 1303

E27, 46W Halo
Aluminium, 1303AL
Grafit, 1303GR
Biały, 1303W
Czarny, 1303B
EEL: A+..D



Art. 1302

5,2W

Aluminium, 1302AL
Grafit, 1302GR
Biały, 1302W
Czarny, 1302B
Moduł LED : 628 lm, 3000K,
>70 000h, ściemniany, EEL: A+

Art. 1305

E27, 46W Halo
Aluminium, 1305AL
Grafit, 1305GR
Biały, 1305W
Czarny, 1305B
EEL: A+..D

ASKER

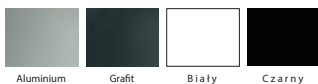

ASKER

NOWOŚĆ

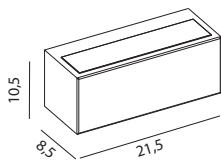

ASKER
IP44, Klasa I
Podstawa: odlew aluminiowy malowany proszkowo.
Front: stal cynkowana ogniwo.
Klosz: PC struktura.

Dla uzyskania optymalnej efektywności świecenia zalecamy wersję LED.

*Uwaga: Nie obracać tylnej płyty.

NOWOŚĆ



Art.1700
8W
Ocynk, 1700GA
Moduł LED : 978 lm, 3000K,
>50 000h, ściemniany, EEL: A+

Art.1702
E27, 46W Halo
Ocynk, 1702GA
EEL: A+..D



Art.1705
8W
Ocynk, 1705GA
Moduł LED : 978 lm, 3000K,
>50 000h, ściemniany, EEL: A+

Art.1707
E27, 46W Halo
Ocynk, 1707GA
EEL: A+..D

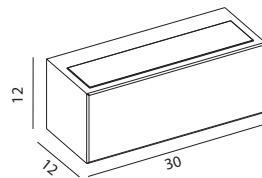

ASKER (big)
IP44, Klasa I
Podstawa: odlew aluminiowy malowany proszkowo.
Front: stal cynkowana ogniwo.
Klosz: PC struktura.

Dla uzyskania optymalnej efektywności świecenia zalecamy wersję LED.

* Wersja 4000K - dostępność oraz termin realizacji po ustaleniu z Działem Handlowym Norlys Sp. z o.o.

*Uwaga: Nie obracać tylnej płyty.

NOWOŚĆ



Art. 1710
9,3W
Ocynk, 1710GA
Moduł LED : 2x628 lm,
3000K, >70 000h, EEL: A+

Art. 1712
E27, 46W Halo
Ocynk, 1712GA
EEL: A+..D



Art. 1715
5,2W
Ocynk, 1715GA
Moduł LED : 628 lm, 3000K,
>70 000h, ściemniany, EEL: A+

Art. 1717
E27, 46W Halo
Ocynk, 1717GA
EEL: A+..D



ASKER SŁUPKOWY



LED



Aluminium Grafit Czarny



ASKER SŁUPOWY

NOWOŚĆ



LED

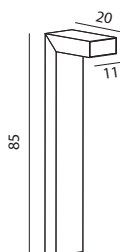

ASKER SŁUPKOWY
IP65, Klasa I

Oprawa: odlew aluminiowy malowany proszkowo.
Klosz: PC struktura.

Akcesoria

Kotwa - Art. 1907
Kotwa - Art. 1908

Art.1311
10W
Aluminium, 1311AL
Grafit, 1311GR
Czarny, 1311B
Moduł LED: 1100 lm, 3000K,
>50 000h, ściemniający, EE: A+

Art.1312 (Dali)
11,6W
Aluminium, 1312AL
Grafit, 1312GR
Czarny, 1312B
Moduł LED: 1100 lm,
3000K, >50 000h, EE: A+
Dali, 1..100% dali interface

ASKER SŁUPOWY
IP65, Klasa I

Oprawa: odlew aluminiowy malowany proszkowo.
Klosz: PC struktura.

Akcesoria

Kotwa - Art. 116
Kotwa - Art. 117

NOWOŚĆ

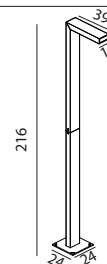

Art.1360
18W
Aluminium, 1360AL
Grafit, 1360GR
Czarny, 1360B
Moduł LED: 1710 lm, 3000K,
>50 000h, ściemniający, EE: A+

Art. 1360. słup 2-częściowy, do transportu paletowego w poziomie.

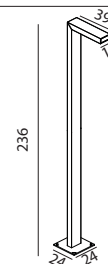

Art.1363
18W
Aluminium, 1363AL
Grafit, 1363GR
Czarny, 1363B
Moduł LED: 1710 lm, 3000K,
>50 000h, ściemniający, EE: A+

Art. 1360. słup 1-częściowy.



LILLEHAMMER



LED



Aluminium Grafit Biały Czarny

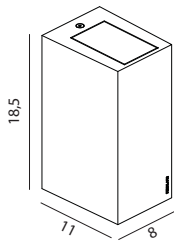

LILLEHAMMER
IP65, klasa I

Oprawa:
odlew aluminiowy
malowany proszkowo.

Klosz:
szkło bezpieczne
przeźroczyste.

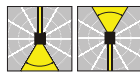

Art. 1580 
2x4W
Aluminium, 1580AL
Grafit, 1580GR
Biały, 1580W
Czarny, 1580B
Moduł LED : 2x305 lm,
3000K, >50 000h, EEL: A+



Art. 1581 
2x4W
Aluminium, 1581AL
Grafit, 1581GR
Biały, 1581W
Czarny, 1581B
Moduł LED : 2x305 lm,
3000K, >50 000h, EEL: A+



Art. 1582 
4W
Aluminium, 1582AL
Grafit, 1582GR
Biały, 1582W
Czarny, 1582B
Moduł LED : 305 lm,
3000K, >50 000h, EEL: A+



Art. 1583 
2x4W
Aluminium, 1583AL
Grafit, 1583GR
Biały, 1583W
Czarny, 1583B
Moduł LED : 2x305 lm,
3000K, >50 000h, EEL: A+

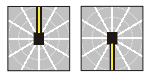

Art. 1584 
4W
Aluminium, 1584AL
Grafit, 1584GR
Biały, 1584W
Czarny, 1584B
Moduł LED : 305 lm,
3000K, >50 000h, EEL: A+



BODEN

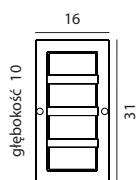
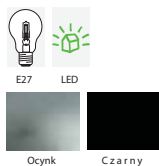

BODEN
IP54, Klasa I

Podstawa: odlew aluminiowy malowany proszkowo.

Front: stal cynkowa ognioowo lub odlew aluminiowy malowany proszkowo.

Klosz: PC mleczny lub przezroczysty.

Art.860
E27, 46W Halo
PC mleczny
O cynk, 860GA
Czarny, 860B
EEI: A+..D

Art.862
E27, 46W Halo
PC przezroczysty
O cynk, 862GA
Czarny, 862B
EEI: A+..D

Art. 866 
8W
PC mleczny
O cynk, 866GA
Czarny, 866B
Moduł LED: 978 lm, 3000K,
>50 000h, ściemniający, EEI: A+

NORDKAPP

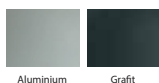

NORDLAND

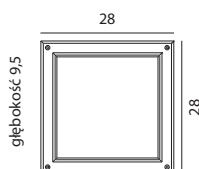
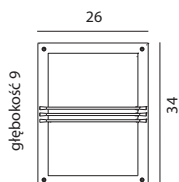
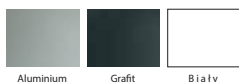

NORDKAPP IP65, klasa I

Oprawa:
odlew aluminiowy
malowany proszkowo.

Klosz: PC mleczny.

* Wersja 4000K - dostępność
oraz termin realizacji po ust-
aleniu z Działem Handlowym
Norlys Sp. z o.o.

NORDKAPP
Art. 1620
10W
Aluminium, 1620AL
Grafit, 1620GR
Moduł LED : 1100 lm, 3000K,
>50 000h, ściemniający, EEI: A+

Art. 1621
2x max 9W, E27, LED
Aluminium, 1621AL
Grafit, 1621GR
EEI: A+..D

NORDLAND IP65, klasa I

Oprawa:
odlew aluminiowy
malowany proszkowo.

Klosz: PC mleczny.

Nordland - możliwość
montażu ściennego
oraz na suficie.

* Wersja 4000K - dostępność
oraz termin realizacji po
ustaleniu z Działem Handlowym
Norlys Sp. z o.o.

NORDLAND
Art. 718
10W
Aluminium, 718AL
Grafit, 718GR
Biały, 718W
Moduł LED : 1100 lm, 3000K,
>50 000h, ściemniający, EEI: A+

Art. 719
12,9W
Aluminium, 719AL
Grafit, 719GR
Biały, 719W
Moduł LED : 1500 lm,
3000K, >50 000h, EEI: A+

NORDLAND
Art. 5040
13,6W
Aluminium, 5040AL
Grafit, 5040GR
Biały, 5040W
Moduł LED : 1500 lm,
3000K, >50 000h, EEI: A+

Moduł LED ściemniający, ze
zintegrowanym czujnikiem ruchu
HF i wyłącznikiem zmierzchowym.

NORDLAND
Art. 5041
17,5W
Aluminium, 5041AL
Grafit, 5041GR
Biały, 5041W
Moduł LED : 1950 lm,
3000K, >50 000h, EEI: A+

Art. 7120
2x max 9W, E27, LED
Aluminium, 7120AL
Grafit, 7120GR
Biały, 7120W
EEI: A+..D



SANDVIK



GU 10
LED

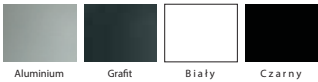

Aluminium Grafit Biały Czarny

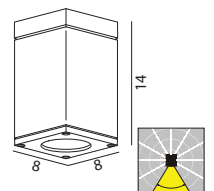
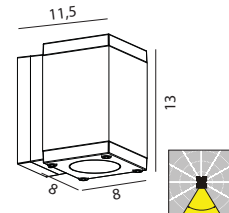
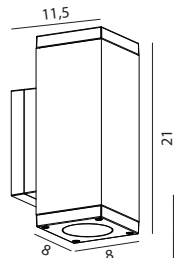

SANDVIK
Klasa I
Art. 791- 794: IP65
Art. 795- 796: IP54

Oprawa: odlew
alumirowy malowany
proszkowo.

Klosz: szkło bezpieczne.

Art. 791
2x25W max, GU 10
Aluminium, 791AL
Grafit, 791GR
Biały, 791W
Czarny, 791B
EEI: A+..D

Art. 792
2x3,9W
Aluminium, 792AL
Grafit, 792GR
Biały, 792W
Czarny, 792B
Zawiera 2x3,9W LED, GU10, 2x265
lm, 2700K, 40000h, 25D, ściemniający
EEI: A+

Art. 793
25W max, GU 10
Aluminium, 793AL
Grafit, 793GR
Biały, 793W
Czarny, 793B
EEI: A+..D

Art. 794
3,9W
Aluminium, 794AL
Grafit, 794GR
Biały, 794W
Czarny, 794B
Zawiera 3,9W LED, GU10, 265 lm,
2700K, 40000h, 25D, ściemniający
EEI: A+

Art. 795
25W max, GU 10
Aluminium, 795AL
Grafit, 795GR
Biały, 795W
Czarny, 795B
EEI: A+..D

Art. 796
3,9W
Aluminium, 796AL
Grafit, 796GR
Biały, 796W
Czarny, 796B
Zawiera 3,9W LED, GU10, 265 lm,
2700K, 40000h, 25D, ściemniający
EEI: A+



MANDAL

NOWOŚĆ



GU10
LED



Ocynk

Czarny

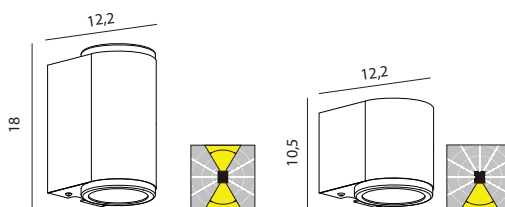

SANDVIK
IP44, Klasa I

Oprawa: stal
cynkowana ogniowo i
malowana proszkowo
w standardzie.

Klosz: szkło bezpieczne.

Art. 1370

2x3,9W

Ocynk 1370GA

Czarny, 1370B

Zawiera 2x3,9W LED, GU10, 2x265 lm,
2700K, 40000h, 25D, ściemniający
EEI: A+

Art. 1371

2x25W max, GU 10

Ocynk 1371GA

Czarny, 1371B

EEI: A+..D

Art. 1373

3,9W

Ocynk 1373GA

Czarny, 1373B

Zawiera 3,9W LED, GU10, 265 lm,
2700K, 40000h, 25D, ściemniający
EEI: A+

Art. 1374

25W max, GU 10

Ocynk 1374GA

Czarny, 1374B

EEI: A+..D



Foto: Lars Melkevik

GENEVA

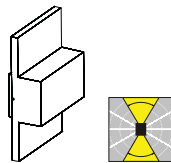
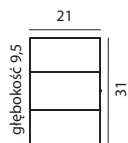

GENEVA
IP54, Klasa I

Oprawa: odlew
alumiowy malowany
proszkowo.

Klosz: PC mleczny.

Art. 874
E27, 46W Halo
Aluminium, 874AL
Grafit, 874GR
Biały, 874W
Czarny, 874B
EEI: A+..D

Art. 879 
8W
Aluminium, 879AL
Grafit, 879GR
Biały, 879W
Czarny, 879B
Moduł LED : 978 lm, 3000K,
>50 000h, ściemniający, EEI: A+

HALDEN

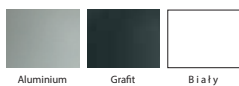

VASA

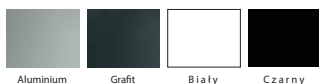

VASA
IP65, Klasa I

Oprawa:
odlew aluminiowy
malowany proszkowo.

Klosz: PC struktura.

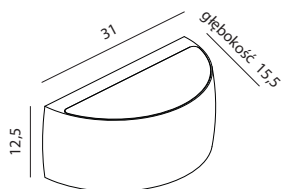

VASA
Art. 120
E27, 57W Halo
Aluminium, 120AL
Grafit, 120GR
Biały, 120W
Czarny, 120B
EEI: A+..D

Art. 127
8,5W
Aluminium, 127AL
Grafit, 127GR
Biały, 127W
Czarny, 127B
Zawiera 8,5W LED, E27, 806 lm,
2700K, 25000h, ściemniający, EEI: A+



HALDEN
IP65, Klasa I

Oprawa:
odlew aluminiowy
malowany proszkowo.

Klosz: PC struktura.

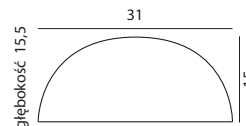

HALDEN
Art. 510
E27, 57W Halo
Aluminium, 510AL
Grafit, 510GR
Biały, 510W
EEI: A+..D

Art. 515
8,5W
Aluminium, 515AL
Grafit, 515GR
Biały, 515W
Zawiera 8,5W LED, E27, 806 lm,
2700K, 25000h, ściemniający,
EEI: A+

HALDEN
Art. 517
8,8W
Aluminium, 517AL
Grafit, 517GR
Biały, 517W
Moduł LED : 1027 lm,
3000K, >50 000h, EEI: A++

* Wersja 4000K i/lub DALI
- dostępność oraz termin
realizacji po ustaleniu
z Działem Handlowym
Norlrys Sp. z o.o.



BERNO

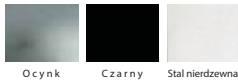

BAZYLEA

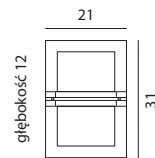
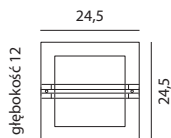

BERNO

IP54, klasa I
Podstawa aluminiowa, front stal cynkowana ogniowo, stal nierdzewna lub stal malowana proszkowo.

BERNO
Art. 650
szklany przezroczysty
E27, 46W Halo
O cynk, 650GA
Czarny, 650B
Stal nierdzewna, 650ST
EEI: A+..D

Art. 651
satynowany
E27, 46W Halo
O cynk, 651GA
Czarny, 651B
Stal nierdzewna, 651ST
EEI: A+..D

BERNO
Art. 655
satynowany
6W
O cynk, 655GA
Czarny, 655B
Stal nierdzewna, 655ST
Moduł LED: 628 lm, 3000K, >70 000h, EEI: A++

Art. 657
satynowany
4,5W
O cynk, 657GA
Czarny, 657B
Stal nierdzewna, 657ST
Moduł LED: 428 lm, 3000K, >50 000h, ściemniający, EEI: A+

BAZYLEA

IP54, Klasa I
Podstawa aluminiowa, front stal cynkowana ogniowo, stal nierdzewna lub stal malowana proszkowo.

BAZYLEA
Art. 660
szklany przezroczysty
E27, 57W Halo
O cynk, 660GA
Czarny, 660B
Stal nierdzewna, 660ST
EEI: A+..D

Art. 661
satynowany
E27, 57W Halo
O cynk, 661GA
Czarny, 661B
Stal nierdzewna, 661ST
EEI: A+..D

BAZYLEA
Art. 668
satynowany
6W
O cynk, 668GA
Czarny, 668B
Stal nierdzewna, 668ST
Moduł LED: 628 lm, 3000K, >70 000h, EEI: A++

Art. 681
satynowany
4,5W
O cynk, 681GA
Czarny, 681B
Stal nierdzewna, 681ST
Moduł LED: 428 lm, 3000K, >50 000h, ściemniający, EEI: A+



LILLESAND

NOWOŚĆ



LED



Aluminium

Grafit

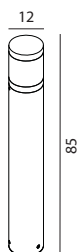

LILLESAND
IP65, Klasa I

Oprawa: odlew aluminiowy
malowany proszkowo.

Klosz: PMMA satynowany.

Akcesoria

Kotwa - Art. 205
Kotwa - Art. 206
Kotwa - Art. 206S

Art. 1380
E27, 46W Halo
Aluminium, 1380AL
Grafit, 1380GR
EEL: A+..D

Art. 1382 
8,5W, E27
Aluminium, 1382AL
Grafit, 1382GR
Zawiera 8,5W LED, E27, 806 lm,
2700K, 25000h, ściemniający,
EEL: A+

OPPLAND



LED



Aluminium



Graft

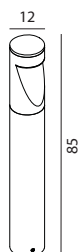

OPPLAND
IP54, Klasa I

Oprawa:
odlew aluminiowy
malowany proszkowo.

Klosz: PC struktura.

Akcesoria

Kotwa - Art. 205
Kotwa - Art. 206
Kotwa - Art. 206S

Art. 1321
10,7W 
Aluminium, 1321AL
Graft, 1321GR
Modul LED : 1180 lm,
3000K, >50 000h, EE: A++



MOLDE



LED



Aluminium

Grafit

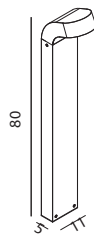

MOLDE
IP54, Klasa I

Oprawa: odlew aluminiowy
malowany proszkowo.

Klosz: PC struktura.

Art. 1901 
8W
Aluminium, 1901AL
Grafit, 1901GR
Moduł LED : 978 lm, 3000K,
>50 000h, ściemniający, EE: A+

Akcesoria
Kotwa - Art. 1906
Kotwa - Art. 1907
Kotwa - Art. 1908

ARENDAŁ



E14



Ocynk

Czarny

Grafit



ARENDAŁ



E27



Ocynk

Czarny

Grafit

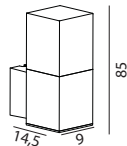

ARENDAŁ

IP65, Klasa II

Oprawa: stal cynkowana
ogniowo i malowana
proszkowo w standardzie.

Klosz: szkło kryształ.

**Oprawy Arendal dostępne
tylko w Polsce.**

Art. 1250

E14, 46W Halo
Ocynk, 1250GA
Czarny, 1250B
Grafit, 1250GR
EEI: A+,D

ARENDAŁ SŁUPKOWY

IP65, Klasa II

Oprawa: stal cynkowana
ogniowo i malowana proszkowo
w standardzie.

Klosz: szkło kryształ.

**Oprawy Arendal dostępne
tylko w Polsce.**

Akcesoria

Do art. 1560, 1565 i 1569

Kotwa - Art. 205

Kotwa - Art. 206

Kotwa - Art. 206S



Art. 1560

E27, 46W Halo
Ocynk, 1560GA
Czarny, 1560B
Grafit, 1560GR
EEI: A+,D

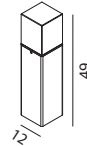

Art. 1565

E27, 46W Halo
Ocynk, 1565GA
Czarny, 1565B
Grafit, 1565GR
EEI: A+,D

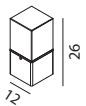

Art. 1569

E27, 46W Halo
Ocynk, 1569GA
Czarny, 1569B
Grafit, 1569GR
EEI: A+,D



HALMSTAD

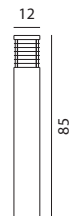
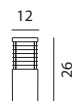

HALMSTAD
IP65, Klasa II
Art. 1489, 1482, Klasa I

Oprawa: stal cynkowa
ogniowo i malowana
proszkowo w standardzie.

Klosz: PC mleczny.

Aksesoria
Kotwa - Art. 205
Kotwa - Art. 206
Kotwa - Art. 206S

Art. 210
E27, 46W Halo
O cynk, 210GA
Czarny, 210B
Grafit, 210GR
EEI: A+..D

Art. 211 
8W
O cynk, 210GA
Czarny, 210B
Grafit, 210GR
Moduł LED : 978 lm, 3000K,
>50 000h, ściemniający,
EEI: A+

Art. 295
E27, 46W Halo
O cynk, 295GA
Czarny, 295B
Grafit, 295GR
EEI: A+..D

Art. 1488 
8,5W, E27
O cynk, 1488GA
Czarny, 1488B
Grafit, 1488GR
Zawiera 8,5W LED, E27,
806 lm, 2700K, 25000h,
ściemniający, EEI: A+

Art. 1489 
8W
O cynk, 1489GA
Czarny, 1489B
Grafit, 1489GR
Moduł LED : 978 lm, 3000K,
>50 000h, ściemniający,
EEI: A+

Art. 296
E27, 46W Halo
O cynk, 296GA
Czarny, 296B
Grafit, 296GR
EEI: A+..D

Art. 1482 
8W
O cynk, 1482GA
Czarny, 1482B
Grafit, 1482GR
Moduł LED : 978 lm, 3000K,
>50 000h, ściemniający,
EEI: A+

Art. 1483 
8,5W, E27
O cynk, 1483GA
Czarny, 1483B
Grafit, 1483GR
Zawiera 8,5W LED, E27,
806 lm, 2700K, 25000h,
ściemniający, EEI: A+

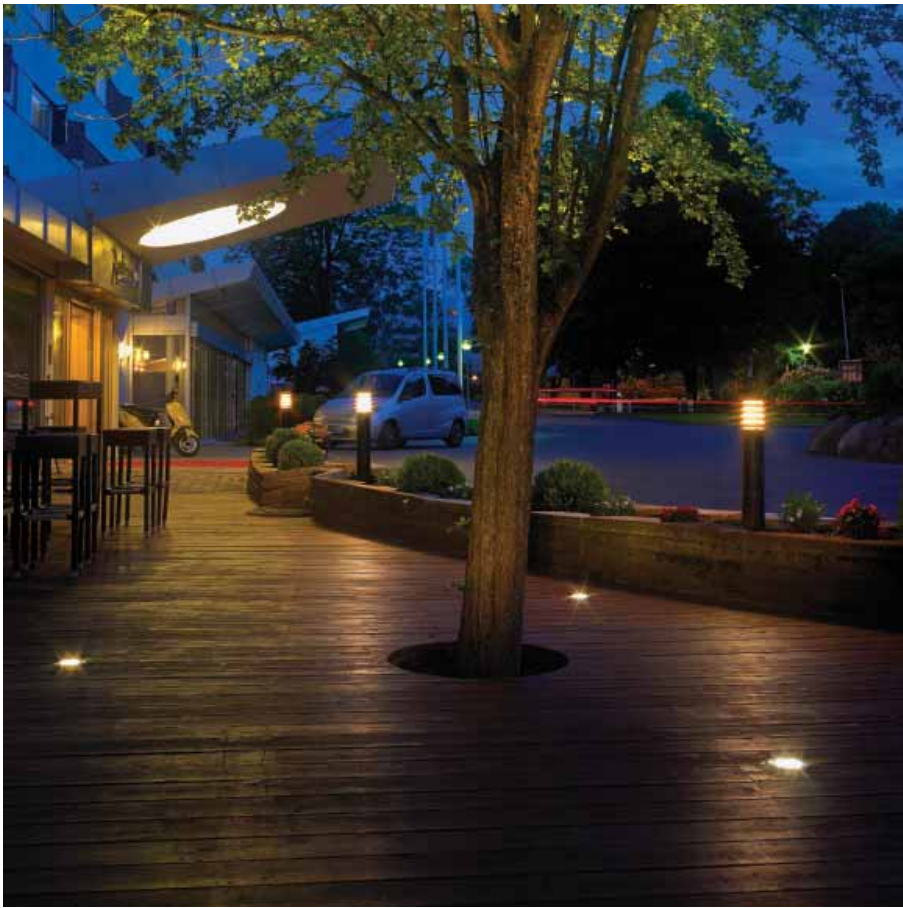

ALTA



Art. 291
E27, 46W Halo
Ocynk, 291GA
Czarny, 291B
EEI: A+..D

Art. 1475
8,5W, E27
Ocynk, 1475GA
Czarny, 1475B
Zawiera 8,5W LED, E27,
806 lm, 2700K, 25000h,
ściemnialny, EEI: A+

ALTA
IP65, Klasa II
Art. 1476, 1479 Klasa I

Oprawa: stal cynkowana
ogniowo i malowana
proszkowo w standardzie.

Klosz: PC mleczny.

Akcesoria
Kotwa - Art. 205
Kotwa - Art. 206
Kotwa - Art. 206S

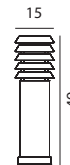

Art. 1479
8W
Ocynk, 1479GA
Czarny, 1479B
Moduł LED : 978 lm, 3000K,
>50 000h, ściemnialny,
EEI: A+

Art. 293
E27, 46W Halo
Ocynk, 293GA
Czarny, 293B
EEI: A+..D

Art. 1476
8W
Ocynk, 1476GA
Czarny, 1476B
Moduł LED : 978 lm, 3000K,
>50 000h, ściemnialny,
EEI: A+

Art. 1477
8,5W, E27
Ocynk, 1477GA
Czarny, 1477B
Zawiera 8,5W LED, E27, 806 lm,
2700K, 25000h, ściemnialny,
EEI: A+

SKANDYNAWSKIE DREWNO



E27



O cynk Czarny

Nasz asortyment drewnianych słupków idealnie wpisuje się w wiele różnorodnych projektów, łącząc nowoczesne oświetlenie i naturalne materiały. Wykorzystujemy pierwszy gatunek sosny skandynawskiej, impregnowanej w celu jej jak najlepszej ochrony. Drewniany korpus występuje w wersji impregnowanej bądź dwukrotnie malowanej. Oznaczenie * - wersja tylko impregnowana *:wybarwienie na życzenie klienta. Elementy z drewna skandynawskiego należy konserwować zgodnie z zaleceniami wskazanymi w Ogólnych Warunkach Użytkowania Norlys Sp. z o.o.

Elementy z drewna Skandynawskiego objęte są dwuletnią gwarancją pod warunkiem, zalecanej w Ogólnych Warunkach Użytkowania, odpowiedniej corocznej konserwacji.

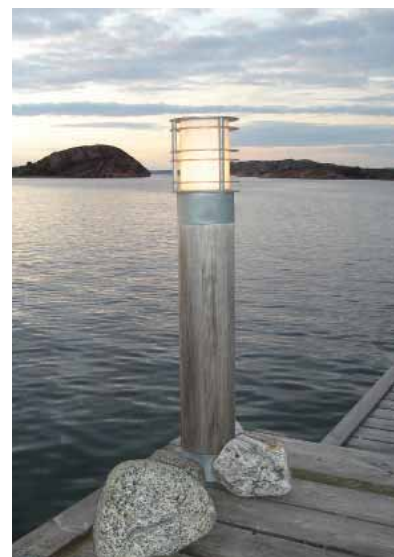

HALMSTAD



STOCKHOLM



ALTA

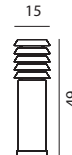
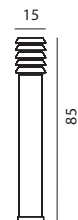
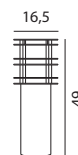
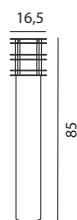
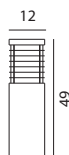

SKANDYNAWSKIE DREWNO IP65, Klasa II

Oprawa: drewno ze skandynawskiej sosny, malowane lub impregnowane.
Okucia: stalowe okucia malowane proszkowo i cynkowane ogniowo.
Klosz: PC mleczny.

Aksesoria
Kotwa - Art. 205
Kotwa - Art. 206
Kotwa - Art. 206S

Halmstad (drewno)
Art. 1400
E27, 46W Halo
O cynk, 1400GA
Czarny, 1400B
EEI: A+.D

***Art. 1403**
E27, 46W Halo
O cynk, 1403GA
Czarny, 1403B
EEI: A+.D

Halmstad (drewno)
Art. 1410
E27, 46W Halo
O cynk, 1410GA
Czarny, 1410B
EEI: A+.D

***Art. 1413**
E27, 46W Halo
O cynk, 1413GA
Czarny, 1413B
EEI: A+.D

Stockholm (drewno)
Art. 1420
E27, 46W Halo
O cynk, 1420GA
Czarny, 1420B
EEI: A+.D

***Art. 1423**
E27, 46W Halo
O cynk, 1423GA
Czarny, 1423B
EEI: A+.D

Stockholm (drewno)
Art. 1430
E27, 46W Halo
O cynk, 1430GA
Czarny, 1430B
EEI: A+.D

***Art. 1433**
E27, 46W Halo
O cynk, 1433GA
Czarny, 1433B
EEI: A+.D

Alta (drewno)
Art. 1440
E27, 46W Halo
O cynk, 1440GA
Czarny, 1440B
EEI: A+.D

***Art. 1443**
E27, 46W Halo
O cynk, 1443GA
Czarny, 1443B
EEI: A+.D

Alta (drewno)
Art. 1450
E27, 46W Halo
O cynk, 1450GA
Czarny, 1450B
EEI: A+.D

***Art. 1453**
E27, 46W Halo
O cynk, 1453GA
Czarny, 1453B
EEI: A+.D



STOCKHOLM



E27

LED



O cynk

Czarny

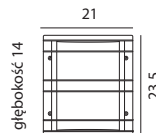

STOCKHOLM IP54, Klasa I

Podstawa: odlew aluminiowy malowany proszkowo.

Front: stal cynkowana ogniowo i malowana proszkowo w standardzie.

Klosz: PC przezroczysty lub mleczny.

Art. 220
Klosz: PC mleczny
E27, 46W Halo
O cynk, 220GA
Czarny, 220B
EE: A+..D

Art. 226
PC przezroczysty
E27, 46W Halo
O cynk, 222GA
Czarny, 222B
EE: A+..D

Art. 1600 
PC mleczny
8W
O cynk, 1600GA
Czarny, 1600B
Moduł LED: 978 lm, 3000K,
>50 000h, ściemniany,
EE: A+



STOCKHOLM



Art. 288
PC mleczny
E27, 46W Halo
O cynk, 288GA
Czarny, 288B
EEI: A+.D

Art. 297
PC przezroczysty
E27, 46W Halo
O cynk, 297GA
Czarny, 297B
EEI: A+.D

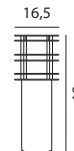

Art. 1265
PC mleczny
8W
O cynk, 1265GA
Czarny, 1265B
Moduł LED: 978 lm, 3000K,
>50 000h, ściemniający,
EEI: A+

Art. 289
PC przezroczysty
E27, 46W Halo
O cynk, 289GA
Czarny, 289B
EEI: A+.D

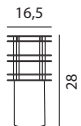

Art. 1260
PC mleczny
8W
O cynk, 1260GA
Czarny, 1260B
Moduł LED: 978 lm, 3000K,
>50 000h, ściemniający,
EEI: A+

Art. 299
PC mleczny
E27, 46W Halo
O cynk, 299GA
Czarny, 299B
EEI: A+.D

Art. 1268
PC mleczny
8W
O cynk, 1268GA
Czarny, 1268B
Moduł LED: 978 lm, 3000K,
>50 000h, ściemniający,
EEI: A+

STOCKHOLM
IP65, Klasa II
Art. 1260, 1265: Klasa I

Oprawa: stal cynkowa
ogniowo i malowana
proszkowo w standardzie.

Klosz: PC mleczny (opcjonalnie
możliwość zamówienia klosza
przezroczystego).

Akcesoria
Kotwa - Art. 205
Kotwa - Art. 206
Kotwa - Art. 206S

* Wersja 4000K - dostępność oraz termin realizacji po ustaleniu z Działem Handlowym Norlys Sp. z o.o.



STOCKHOLM



E27



Ocynk Czarny Biały

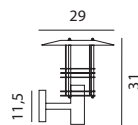

STOCKHOLM IP54, Klasa II

Oprawa: stal cynkowana
ogniwo i malowana
proszkowo w standardzie.

Klosz: PC przezroczysty.

Art. 280
E27, 46W Halo
Ocynk, 280GA
Czarny, 280B
EEI: A+..D

Akcesoria
Narożnik Art. 153
Ocynk, 153GA
Czarny, 153B

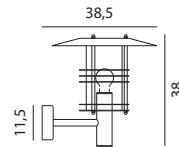

Art. 286
E27, 77W Halo
Ocynk, 286GA
Czarny, 286B
EEI: A+..D

Akcesoria
Narożnik Art. 153
Ocynk, 153GA
Czarny, 153B



STOCKHOLM



E27



O cynk

Czarny

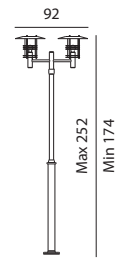
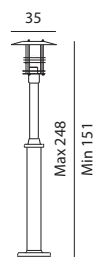
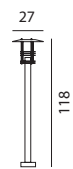
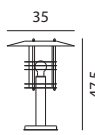
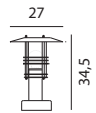

STOCKHOLM IP54, Klasa II

Głowy: stal cynkowa
ogniowo i malowana
proszkowo w standardzie.

Słupy: stal cynkowa
ogniowo lub aluminium
malowane proszkowo.

Klosz: PC przezroczysty.

Art. 284
E27, 46W Halo
O cynk, 284GA
Czarny, 284B
EEI: A+..D

Art. 287
E27, 46W Halo
O cynk, 287GA
Czarny, 287B
EEI: A+..D

Art. 285
E27, 46W Halo
O cynk, 288GA
Czarny, 285B
EEI: A+..D

Art. 281
E27, 77W Halo
O cynk, 281GA
Czarny, 281B
EEI: A+..D

Art. 283
E27, 2x77W Halo
O cynk, 283GA
Czarny, 283B
EEI: A+..D

Kotwy do betonu w zestawie dla Art. 284, 287 i 285.

Akcesoria
Do art. 281 i 283.
Kotwa - 111
Kotwa - 405
Kotwa - 406

BERLIN



BREMEN

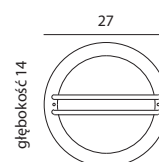
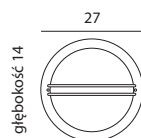

BERLIN
IP54, Klasa I

Oprawa: odlew aluminiowy
malowany proszkowo.

Klosz: PC mleczny lub
przeźroczysty.

BERLIN
Art. 610
PC przeźroczysty
E27, 46W Halo
Czarny, 610B
Biały, 610W
EEI: A+..D

Art. 611
PC mleczny
E27, 46W Halo
Czarny, 611B
Biały, 611W
EEI: A+..D

BERLIN
Art. 615
PC mleczny
8,5W, E27
Czarny, 615B
Biały, 615W
Zawiera 8,5W LED, E27, 806 lm,
2700K, 25000h, ściemniający, EEI: A+

Art. 617
PC mleczny
10W
Czarny, 617B
Biały, 617W
Moduł LED : 1100 lm, 3000K,
>50 000h, ściemniający, EEI: A+

BREMEN
IP54, Klasa I

Podstawa: odlew
aluminiowy malowany
proszkowo.

Front: stal cynkowa
ogniowo i malowana
proszkowo w stan-
dardzie.

Klosz: PC mleczny lub
przeźroczysty

BREMEN
Art. 630
PC przeźroczysty
E27, 46W Halo
O cynk, 630GA
Czarny, 630B
EEI: A+..D

Art. 631
PC mleczny
E27, 46W Halo
O cynk, 631GA
Czarny, 631B
EEI: A+..D

BREMEN
Art. 637
PC mleczny
10W
O cynk, 637GA
Czarny, 637B
Moduł LED : 1100 lm, 3000K,
>50 000h, ściemniający, EEI: A+

RONDANE

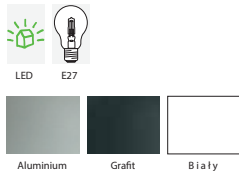

BORNHOLM

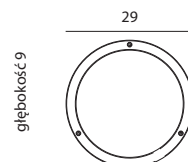
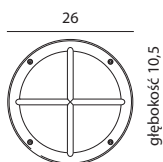
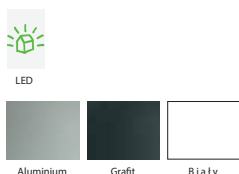

RONDANE
IP65, Klasa I

Oprawa:
odlew aluminiowy
malowany proszkowo.

Klosz: PC mleczny.

Rondane - możliwość
montażu ściennego
oraz na suficie.

Rondane
Art. 537
10W
Aluminium, 537AL
Grafit, 537GR
Biały, 537W
Moduł LED: 1100 lm, 3000K,
>50 000h, ściemniający, EEI: A+

Art. 538
9W max, E27, LED
Aluminium, 538AL
Grafit, 538GR
Biały, 538W
EEI: A+..D

Rondane
Art. 539
17,5W
Aluminium, 539AL
Grafit, 539GR
Biały, 539W
Moduł LED: 1950 lm, 3000K,
>50 000h, ściemniający, EEI: A+

Bornholm
IP65, Klasa I

Oprawa:
odlew aluminiowy
malowany proszkowo.

Klosz: PC mleczny.

Bornholm - możliwość
montażu ściennego
oraz na suficie.

Bornholm
Art. 541
10W
Aluminium, 541AL
Grafit, 541GR
Biały, 541W
Moduł LED: 1100 lm, 3000K,
>50 000h, ściemniający, EEI: A+

Art. 542
17,5W
Aluminium, 542AL
Grafit, 542GR
Biały, 542W
Moduł LED: 1950 lm, 3000K,
>50 000h, ściemniający, EEI: A+



OSLO

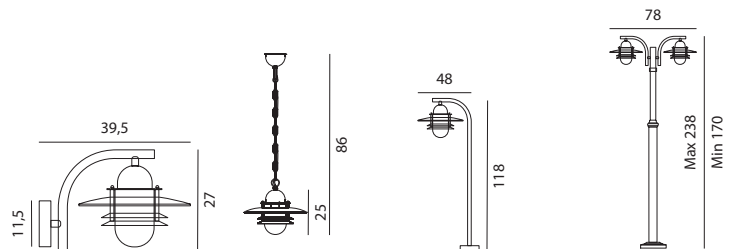

OSLO
IP55, Klasa II

Oprawa: stal cynkowana ogniowo i malowana proszkowo w standardzie.

Klosz: PC lub szklany przezroczysty lub satynowany.

(Możliwość zamówienia Art.240 w miedzi).

Art. 240
E27, 57W Halo
O cynk, 240GA
Czarny, 240B
Miedź, 240CO
EEI: A+,D

Akcesoria
Narożnik Art. 153
O cynk, 153GA
Czarny, 153B
Miedź, 153CO

Art. 240A
E27, 57W Halo
O cynk, 240A/GA
Czarny, 240A/B
EEI: A+,D

Art. 245
E27, 57W Halo
O cynk, 245GA
Czarny, 245B
EEI: A+,D

Akcesoria
W zestawie z kotwami do betonu.

Art. 242
E27, 2x57W Halo
O cynk, 242GA
Czarny, 242B
EEI: A+,D

Akcesoria
Kotwa - 111
Kotwa - 405
Kotwa - 406



OSLO

LARVIK

NOWOŚĆ



E27



Ocynk

Czarny

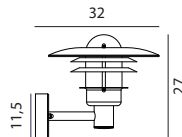

LARVIK
IP55, Klasa II

Oprawa: stal cynkowana
ogniwo i malowana
proszkowo w standardzie.

Klosz: PC lub szklany
przezroczysty lub
satynowany.

NOWOŚĆ

Art. 690
E27, 57W Halo
Ocynk, 690GA
Czarny, 690B
EEL: A+..D

Akcesoria
Narożnik Art. 153
Ocynk, 153GA
Czarny, 153B



LUND



E27



Ocynek

Czarny

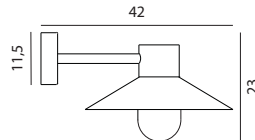

LUND

IP55, Klasa II

Oprawa: stal cynkowa
ogniowo lub malowana
proszkowo.

Klosz: PC lub szklany
przeźroczysty lub
satynowany.

Art. 290

E27, 57W Halo
Ocynek, 290GA
Czarny, 290B
EEI: A+..D

Akcesoria

Narożnik Art. 153
Ocynek, 153GA
Czarny, 153B

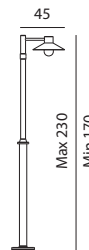

Art. 274

E27, 57W Halo
Ocynek, 274GA
Czarny, 274B
EEI: A+..D

Akcesoria

Do art. 274 i 275.
Kotwa - 111
Kotwa - 405
Kotwa - 406

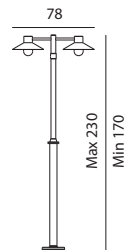

Art. 275

E27, 2x57W Halo
Ocynek, 275GA
Czarny, 275B
EEI: A+..D

PARIS

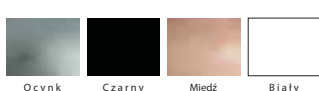

PARIS
IP43, Klasa I

Oprawa: stal malowana proszkowo, stal cynkowana ogniowo lub miedź zabezpieczona chemicznie.

Klosz: PC struktura.

(Tylko Art. 160 w wykonaniu z miedzi).

głębokość 14

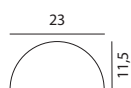

Art. 160
E27, 30W Halo
O cynk, 160GA
Czarny, 160B
Miedź, 160CO
Biały, 160W
EEI: A+,D

Art. 1495 
6W
O cynk, 1495GA
Czarny, 1495B
Biały, 1495W
Moduł LED: 628 lm,
3000K, >70 000h, EEI: A++

głębokość 16

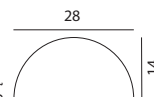

Art. 163
E27, 46W Halo
O cynk, 163GA
Czarny, 163B
Biały, 163W
EEI: A+,D

Art. 1496 
6W
O cynk, 1495GA
Czarny, 1495B
Biały, 1495W
Moduł LED: 628 lm,
3000K, >70 000h, EEI: A++

KARLSTAD

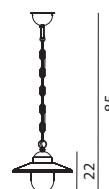
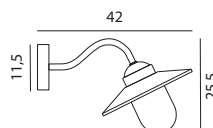
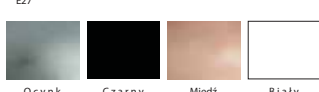

KARLSTAD

IP55, Klasa II

Oprawa:
stal malowana proszkowo
lub cynkowana ognioowo
(opcjonalnie możliwość
zamówienia w miedzi).

Klosz: PC lub szklany
przezroczysty lub
satynowany.

Art. 230

E27, 57W Halo
O cynk, 230GA
Czarny, 230B
Miedź, 230CO
Biały, 230W
EE: A+,..D

Akcesoria

Narożnik Art. 153
O cynk, 153GA
Czarny, 153B
Miedź, 153CO
Biały, 153W

Art. 230A

E27, 57W Halo
O cynk, 230A/GA
Czarny, 230A/B
Biały, 230A/W
EE: A+,..D

BERGEN



E27



Ocynk

Czarny



VANSBRO



E27



Ocynk

Czarny

Miedź

Biały

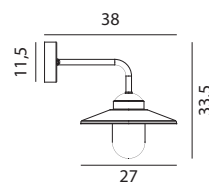
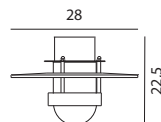
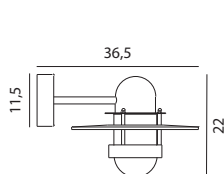

BERGEN IP55, Klasa II

Oprawa: stal cynkowana ogniowo i malowana proszkowo w standardzie.

Klosz: PC lub szklany przezroczysty lub satynowany.

BERGEN Art. 270

E27, 57W Halo
Ocynk, 270GA
Czarny, 270B
EEI: A+..D

Akcesoria
Narożnik Art. 153
Ocynk, 153GA
Czarny, 153B

BERGEN Art. 271

E27, 57W Halo
Ocynk, 271GA
Czarny, 271B
EEI: A+..D

VANSBRO IP55, Klasa II

Oprawa: stal malowana proszkowo lub cynkowana ogniowo (opcjonalnie możliwość zamówienia w miedzi).

Klosz: szklany lub PC.

VANSBRO Art. 1920

E27, 57W Halo
Ocynk, 1920GA
Czarny, 1920B
Miedź, 1920CO
Biały, 1920W
EEI: A+..D

Akcesoria
Narożnik Art. 153
Ocynk, 153GA
Czarny, 153B
Miedź, 153CO
Biały, 153W



ART. 955



CHELSEA



E27



Miedź



ART. 960

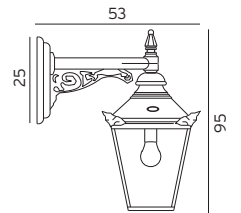
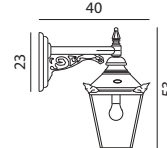
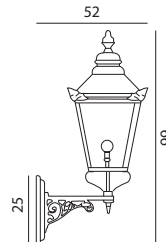
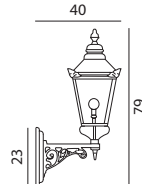
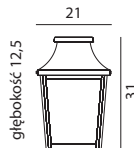
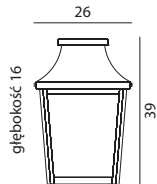
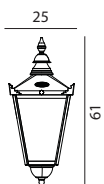

CHELSEA

IP44, Klasa II

Oprawa:
miedź
polerowana
i odlew
aluminiowy
malowany
proszkowo.

Klosz: PC

Art. 950
E27, 77W Halo
Miedź, 950CO
EEI: A+..D

Art. 963
E27, 57W Halo
Miedź, 963CO
EEI: A+..D

Art. 962
E27, 57W Halo
Miedź, 962CO
EEI: A+..D

Art. 954
E27, 77W Halo
Miedź, 954CO
EEI: A+..D

Akcesoria
Narożnik Art. 152
Czarny, 152B

Art. 955
E27, 77W Halo
Miedź, 955CO
EEI: A+..D

Akcesoria
Narożnik Art. 152
Czarny, 152B

Art. 960
E27, 77W Halo
Miedź, 960CO
EEI: A+..D

Akcesoria
Narożnik Art. 152
Czarny, 152B

Art. 964
E27, 77W Halo
Miedź, 964CO
EEI: A+..D

Akcesoria
Narożnik Art. 152
Czarny, 152B



CHELSEA



E27



Miedź

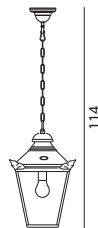

114

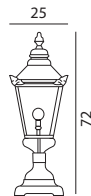

25

72

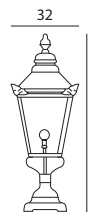

32

88

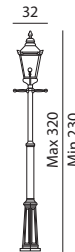

32

Max. 320
Min. 230

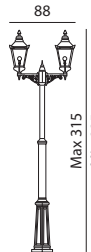

88

Max. 315
Min. 225

CHELSEA
IP44, Klasa II

Oprawa: miedź
polerowana i odlew
aluminiowy malowany
proszkowo.

Klosz: PC przezroczysty.

Art. 961
E27, 77W Halo
Miedź, 961CO
EEI: A+,D

Art. 956
E27, 77W Halo
Miedź, 956CO
EEI: A+,D

Akcesoria
Kotwa - Art. 307

Art. 957
E27, 77W Halo
Miedź, 957CO
EEI: A+,D

Akcesoria
Kotwa - Art. 307

Art. 951
E27, 77W Halo
Miedź, 951CO
EEI: A+,D

Akcesoria Art 951, 953
Kotwa - Art. 108
Kotwa - Art. 305
Kotwa - Art. 306
Słup - Art. 3010
Słup - Art. 30101

Art. 953
E27, 2x77W Halo
Miedź, 953CO
EEI: A+,D



LOFOTEN

NOWOŚĆ



E27



Czarny

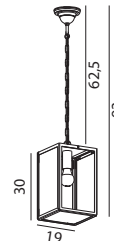
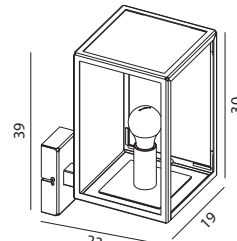
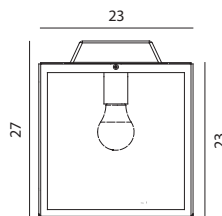
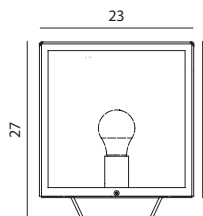
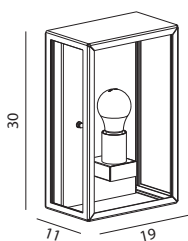

LOFOTEN
IP44, Klasa II

Oprawa: stal malowana
proszkowo.

Klosz: przezroczyste szkło
bezpieczne hartowane.

Art. 1940
E27, 57W Halo
Czarny, 1940B
EEI: A+,D

Art. 1941
E27, 57W Halo
Czarny, 1941B
EEI: A+,D

Art. 1942
E27, 57W Halo
Czarny, 1942B
EEI: A+,D

Art. 1943
E27, 57W Halo
Czarny, 1943B
EEI: A+,D

Oprawa może być
montowana w pozycji:
kinkiet w górę, kinkiet
w dół.

NOWOŚĆ

Art. 1944
E27, 57W Halo
Czarny, 1944B
EEI: A+,D

NOWOŚĆ

LATINA



E27



Czarny Biały



GENUA MINI



E27



Czarny Biały



GENUA



E27



Czarny Biały

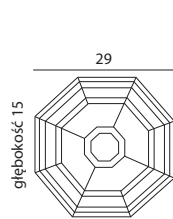

LATINA
Art. 105
E27, 46W Halo
Czarny, 105B
Biały, 105W
EEI: A+..D

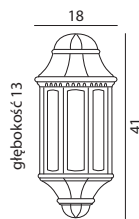

GENUA
Art. 170
E27, 46W Halo
Czarny, 170B
Biały, 170W
EEI: A+..D



GENUA MINI
Art. 175
E27, 46W Halo
Czarny, 175B
Biały, 175W
EEI: A+..D

GLASGOW



E27



Czarny

Biały



TORINO



E27



Czarny

Biały

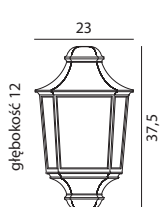

GLASGOW Art. 730

E27, 46W Halo
Czarny, 730B
Biały, 730W
EE: A+..D

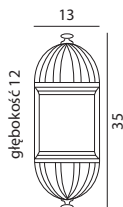

TORINO Art. 750

E27, 46W Halo
Czarny, 750B
Biały, 750W
EE: A+..D



BOLONIA



E27



Czarny

Biały

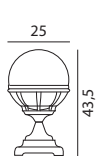
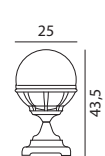
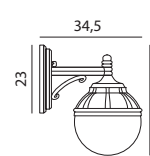
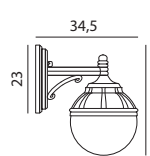
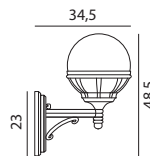
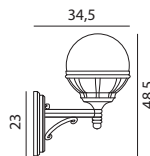

BOLONIA IP54, Klasa II

Oprawa: odlew aluminiowy
malowany proszkowo.

Klosz: akryl przezroczysty
lub mleczny.

Art. 360
przezroczysty
E27, 46W Halo
Czarny, 360B
Biały, 360W
EEI: A+,D

Art. 361
mleczny
E27, 46W Halo
Czarny, 361B
Biały, 361W
EEI: A+,D

Art. 310
przezroczysty
E27, 46W Halo
Czarny, 310B
Biały, 310W
EEI: A+,D

Art. 311
mleczny
E27, 46W Halo
Czarny, 311B
Biały, 311W
EEI: A+,D

Art. 312
przezroczysty
E27, 46W Halo
Czarny, 312B
Biały, 312W
EEI: A+,D

Art. 313
mleczny
E27, 46W Halo
Czarny, 313B
Biały, 313W
EEI: A+,D

Akcesoria
Narożnik Art. 152 do art. 310, 311, 360 i 361

Akcesoria
Kotwa - 307 do art. 312, 313

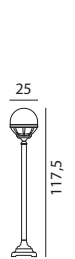

Art. 314
przeźroczysty
E27, 46W Halo
Czarny, 314B
Biały, 314W
EEI: A+,D

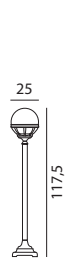

Art. 315
mleczny
E27, 46W Halo
Czarny, 315B
Biały, 315W
EEI: A+,D

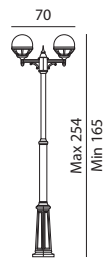

Art. 362
przeźroczysty
E27, 2x46W Halo
Czarny, 362B
Biały, 362W
EEI: A+,D

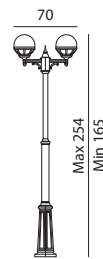

Art. 363
mleczny
E27, 2x46W Halo
Czarny, 363B
Biały, 363W
EEI: A+,D

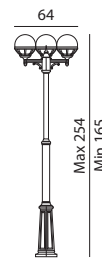

Art. 364
E27, 3x46W Halo
przeźroczysty
EEI: A+,D

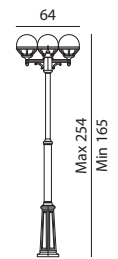

Art. 365
E27, 3x46W Halo
mleczny
EEI: A+,D

Akcesoria
Kotwa - 307 do art. 314, 315

Akcesoria
Do art. 362, 363, 364 i 365
Kotwa - 108
Kotwa - 305
Kotwa - 306
Słup - 3010
Słup - 30101

LONDON



E27



Czarny

Biały



LONDON RODZINA →

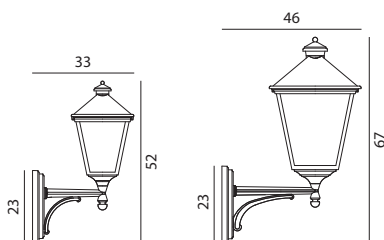

Art. 480

E27, 77W Halo
Czarny, 480B
Biały, 480W
EEI: A+..D

Art. 490

E27, 77W Halo
Czarny, 490B
Biały, 490W
EEI: A+..D

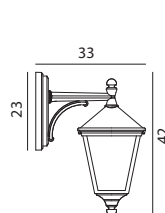

Art. 481

E27, 77W Halo
Czarny, 481B
Biały, 481W
EEI: A+..D

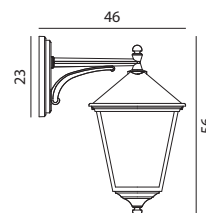

Art. 493

E27, 77W Halo
Czarny, 493B
Biały, 493W
EEI: A+..D

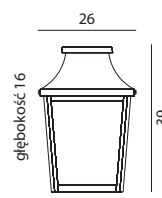

Art. 497

E27, 77W Halo
Czarny, 497B
Biały, 497W
EEI: A+..D

LONDON

IP54, Klasa II

Oprawa:
odlew aluminiowy
malowany proszkowo.

Klosz: PC przezroczysty.

Akcesoria

Narożnik Art. 152 do art. 480, 481, 490 i 493



LONDON



E27



Czarny

Biały

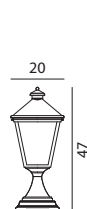

Art. 484
E27, 77W Halo
Czarny, 484B
Biały, 484W
EEI: A+..D

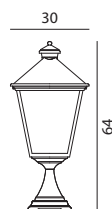

Art. 494
E27, 77W Halo
Czarny, 494B
Biały, 494W
EEI: A+..D

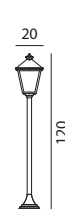

Art. 485
E27, 77W Halo
Czarny, 485B
Biały, 485W
EEI: A+..D

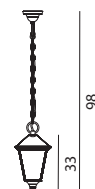

Art. 481A
E27, 77W Halo
Czarny, 481A/B
Biały, 481A/W
EEI: A+..D

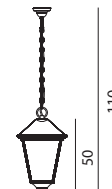

Art. 493A
E27, 77W Halo
Czarny, 493A/B
Biały, 493A/W
EEI: A+..D

LONDON
IP54, Klasa II

Oprawa:
odlew aluminiowy
malowany proszkowo.

Klosz: PC przezroczysty.

Akcesoria

Kotwa - 307 do art. 484, 485 i 494.

LONDON

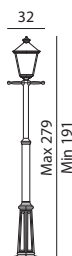

Art. 491
E27, 77W Halo
Czarny, 491B
Biały, 491W
EEI: A+..D

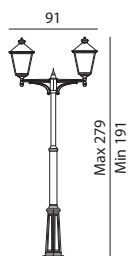

Art. 492
E27, 2x77W Halo
Czarny, 492B
Biały, 492W
EEI: A+..D

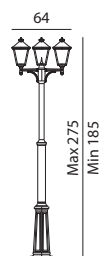

Art. 483
E27, 3x77W Halo
Czarny, 483B
Biały, 483W
EEI: A+..D

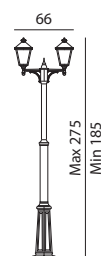

Art. 482
E27, 2x77W Halo
Czarny, 483B
Biały, 483W
EEI: A+..D

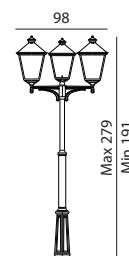

Art. 495
E27, 3x77W Halo
EEI: A+..D

LONDON
IP54, Klasa II

Oprawa:
odlew aluminiowy
malowany proszkowo.

Klosz: PC przezroczysty.

Akcesoria

Do art. 482, 483, 491, 492 i 495
Kotwa - Art. 108
Kotwa - Art. 305
Kotwa - Art. 306
Słup - Art. 3010
Słup - Art. 30101



MODENA



E27



Czarny

Biały

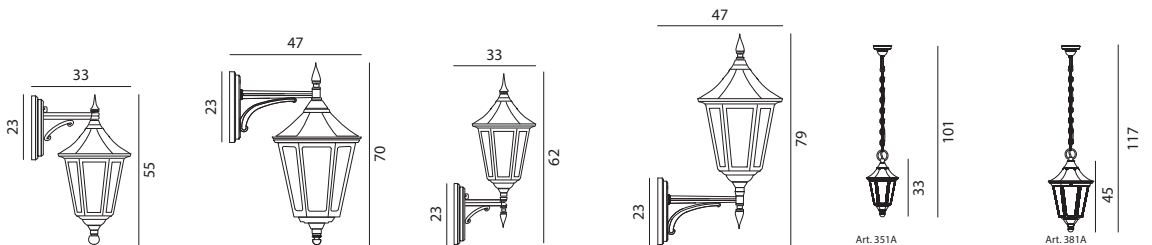

MODENA

IP54, Klasa II

Oprawa: odlew aluminium malowany proszkowo.

Klosz: PC przezroczysty.

*Modena LED bez zintegrowanego klosza.

Art. 351
E27, 77W Halo
Czarny, 351B
Biały, 351W
EEI: A+..D

Art. 381
E27, 77W Halo
Czarny, 381B
Biały, 381W
EEI: A+..D

Art. 350
E27, 77W Halo
Czarny, 350B
Biały, 350W
EEI: A+..D

Art. 380
E27, 77W Halo
Czarny, 380B
Biały, 380W
EEI: A+..D

Art. 351A
E27, 77W Halo
Czarny, 351A/B
Biały, 351A/W
EEI: A+..D

Art. 381A
E27, 77W Halo
Czarny, 381A/B
Biały, 381A/W
EEI: A+..D

Akcesoria
Narożnik Art. 152 350, 351, 380, 381 i 1200.

Art. 1200 
9,5W
Czarny, 1200B
Biały, 1200W
Moduł LED : 1080 lm, 3000K,
>50 000h, Dimmable, EEI: A+

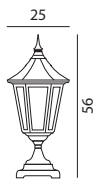

Art. 300
E27, 77W Halo
Czarny, 300B
Biały, 300W
EEI: A+,D



Art. 384
E27, 77W Halo
Czarny, 384B
Biały, 384W
EEI: A+,D



Art. 304
E27, 77W Halo
Czarny, 304B
Biały, 304W
EEI: A+,D

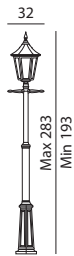

Art. 301
E27, 77W Halo
Czarny, 301B
Biały, 301W
EEI: A+,D

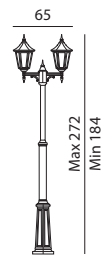

Art. 302
E27, 2x77W Halo
Czarny, 302B
Biały, 302W
EEI: A+,D

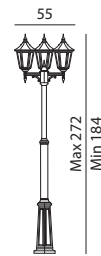

Art. 303
E27, 3x77W Halo
Czarny, 303B
Biały, 303W
EEI: A+,D

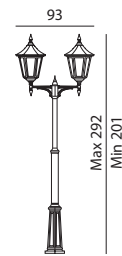

Art. 382
E27, 2x77W Halo
Czarny, 382B
Biały, 382W
EEI: A+,D

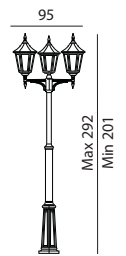

Art. 397
E27, 3x77W Halo
Czarny, 397B
Biały, 397W
EEI: A+,D

Do art. 300, 304 i 384
Kotwa - 307

Art. 1207 
9,5W
Czarny, 1207B
Biały, 1207W
Moduł LED: 1080 lm, 3000K,
>50 000h, Dimmable, EEI: A+

Akcesoria
Do art. 301, 302, 303, 382 i 397
Kotwa - 108
Kotwa - 305
Kotwa - 306
Słup - 3010
Słup - 30101



COMO

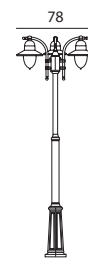
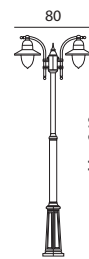
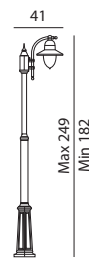
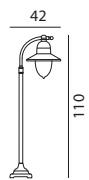
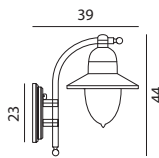

COMO

IP54, Klasa II

Oprawa: odlew aluminiowy malowany proszkowo.

Klosz: PC przezroczysty (opcjonalnie możliwość zamówienia klosza mlecznego).

Art. 370
E27, 57W Halo
Czarny, 370B
Biały, 370W
EEI: A+..D

Akcesoria
Narożnik Art. 152

Art. 375
E27, 57W Halo
Czarny, 375B
Biały, 375W
EEI: A+..D

Akcesoria
Kotwa - Art. 307

Art. 371
E27, 57W Halo
Czarny, 371B
Biały, 371W
EEI: A+..D

Akcesoria
Do art. 371, 372, 373
Kotwa - Art. 108
Kotwa - Art. 305
Kotwa - Art. 306
Słup - Art. 3010
Słup - Art. 30101

Art. 372
E27, 2x57W Halo
Czarny, 372B
Biały, 372W
EEI: A+..D

Art. 373
E27, 3x57W Halo
Czarny, 373B
Biały, 373W
EEI: A+..D



FLORENCJA



E27



Czarny

Biały

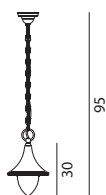

FLORENCJA

IP54, Klasa II

Oprawa:
odlew aluminiowy
malowany proszkowo.

Klosz: PC przezroczysty
(opcjonalnie
możliwość zamówienia
klosza mlecznego).

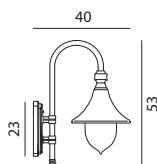

Art. 800A

E27, 57W Halo
Czarny, 800A/B
Biały, 800A/W
EEI: A+..D

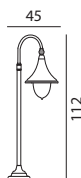

Art. 805

E27, 57W Halo
Czarny, 805B
Biały, 805W
EEI: A+..D

Akcesoria

Narożnik Art. 152
Czarny, 153B
Biały, 153W

Akcesoria

Kotwa - Art. 307

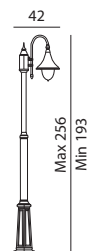

Art. 810

E27, 57W Halo
Czarny, 810B
Biały, 810W
EEI: A+..D

Akcesoria

Do art. 371, 372, 373

Kotwa - Art. 108
Kotwa - Art. 305
Kotwa - Art. 306
Słup - Art. 3010
Słup - Art. 30101

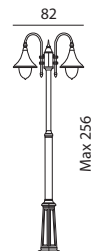

Art. 820

E27, 2x57W Halo
Czarny, 820B
Biały, 820W
EEI: A+..D

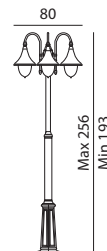

Art. 830

E27, 3x57W Halo
Czarny, 830B
Biały, 830W
EEI: A+..D



RIMINI/MILANO



E27



Czarny

Biały

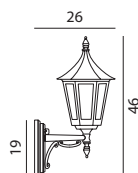

Art. 259

E27, 46W Halo
Czarny, 259B
Biały, 259W
EEI: A+,D

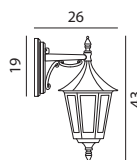

Art. 2591

E27, 46W Halo
Czarny, 251B
Biały, 251W
EEI: A+,D

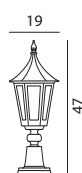

Art. 250

E27, 46W Halo
Czarny, 250B
Biały, 250W
EEI: A+,D

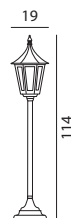

Art. 404

E27, 46W Halo
Czarny, 404B
Biały, 404W
EEI: A+,D

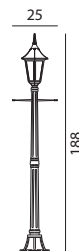

Art. 401

E27, 77W Halo
Czarny, 401B
Biały, 401W
EEI: A+,D



Art. 402

E27, 2x46W Halo
Czarny, 402B
Biały, 402W
EEI: A+,D

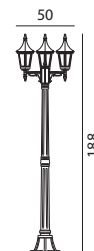

Art. 403

E27, 3x46W Halo
Czarny, 403B
Biały, 403W
EEI: A+,D

RIMINI/MILANO

IP54, Klasa II

Oprawa: odlew aluminiowy malowany proszkowo.

Klosz: PC przezroczysty.

Akcesoria

Narożnik Art. 150 do art. 259 i 2591.
Czarny, 150B
Biały, 150W

Akcesoria

Kotwa - 307 do art. 250 i 404

Akcesoria

Kotwa - Art. 111
Kotwa - Art. 405
Kotwa - Art. 406
Do art. 401, 402 i 403

Źródła światła

Źródło światła

Trzonek

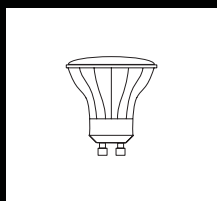
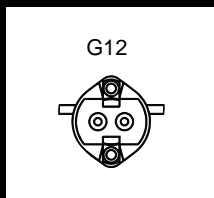
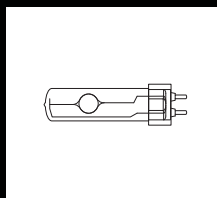
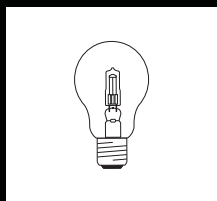

Produkty LED: oznaczone znakiem

LED	HALOGEN	GLS
4W <=>	30W <=>	40W
8-9W <=>	46W <=>	60W
12-13W <=>	57W <=>	75W
14-15W <=>	77W <=>	100W

Klasa energetyczna



Więcej informacji na stronie internetowej: www.norlys.pl

WYMIANA NA NOWĄ GENERACJĘ ŻARÓWEK E27

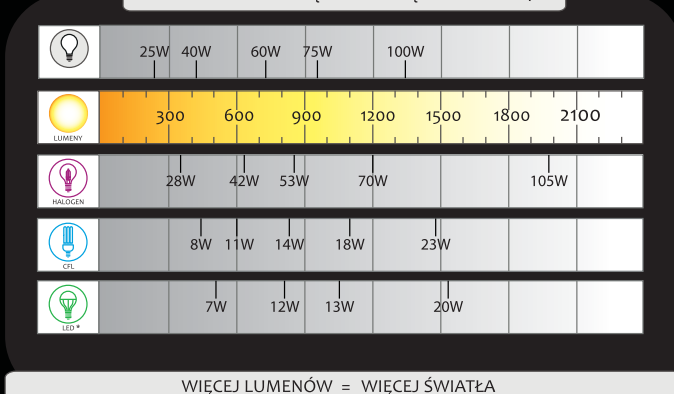

Kolory

Aluminium, RAL 9006



Grafit, RAL 7016

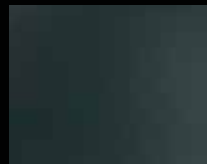

Biały, RAL 9003



Czarny, RAL 9005

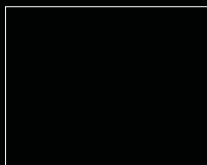

Zielona Patyna



Miedziana patyna

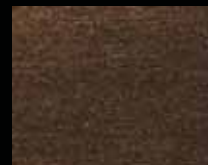

Stal ocynkowana

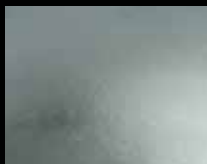

Stal nierdzewna

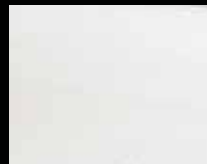

Miedź

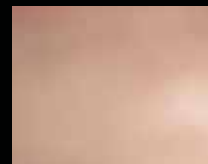

Patyna dostępna tylko dla koloru czarnego i za dopłatą 10%.

Kolory oznaczone jako niestandardowe za dopłatą 30% oraz z wydłużonym terminem realizacji.

Kolory produkowanych opraw mogą się nieznacznie różnić od tych przedstawionych w niniejszym katalogu.

Barwa światła (Kelvin)



Akcesoria

Art. 150
Narożnik
Art: 259, 2591

Art. 152
Narożnik
Art: 310, 311, 360, 361
Art: 350, 351, 380, 381
Art: 370
Art: 480, 481, 490, 493
Art: 800
Art: 954, 960

Art. 153
Narożnik
Art: 230
Art: 240
Art: 270
Art: 280, 286
Art: 290
Art: 690
Art: 1920

Art. 154
Ramię
Art: 575, 576, 577
Art: 777

Art. 156
Narożnik
Art: 882

Art. 158
Narożnik
Art: 886
Art: 720, 724, 725,
1911, 1912

Art. 112
Kotwa
Art: 1931, 1932

Art. 113
Kotwa
Art: 1931, 1932

Art. 114
Kotwa
Art: 1931, 1932

Art. 205
Kotwa
Art: 210, 211, 288, 289,
291, 293, 295, 296, 297,
298, 299, 1260, 1265,
1268, 1290, 1291, 1321,
(1400- 1453)
1477, 1479, 1482,
1483, 1488, 1488

Art. 206
Kotwa
Art: 210, 211, 288, 289,
291, 293, 295, 296, 297,
298, 299, 1260, 1265,
1268, 1290, 1291, 1321,
(1400- 1453)
1477, 1479, 1482,
1483, 1488, 1488

Art. 206S
Kotwa
Art: 210, 211, 288, 289,
291, 293, 295, 296, 297,
298, 299, 1260, 1265,
1268, 1290, 1291, 1321,
(1400- 1453)
1477, 1479, 1482,
1483, 1488, 1488

Art. 305
Kotwa
Art: 301, 302, 303, 382
Art: 362, 363, 364, 365
Art: 371, 372, 373
Art: 482, 483, 493, 492
Art: 810, 820, 830
Art: 951, 953

Art. 305
Kotwa
Art: 301, 302, 303, 382
Art: 362, 363, 364, 365
Art: 371, 372, 373
Art: 482, 483, 493, 492
Art: 810, 820, 830
Art: 951, 953

Art. 108
Kotwa
Art: 301, 302, 303, 382
Art: 362, 363, 364, 365
Art: 371, 372, 373
Art: 482, 483, 493, 492
Art: 810, 820, 830
Art: 951, 953

Art. 307
Kotwa
Art: 300, 304, 384
Art: 312, 313, 314, 315
Art: 484, 485, 494
Art: 805
Art: 956, 957

Art. 207
Kotwa
Art: 891, 893, 898,
899

Art. 110
Kotwa
Art: 557

Art. 405
Kotwa
Art: 242
Art: 274, 275
Art: 281, 283
Art: 401, 402, 403
Art: 1914

Art. 406
Kotwa
Art: 242
Art: 274, 275
Art: 281, 283
Art: 401, 402, 403
Art: 1914

Art. 1230
Kotwa
Art: 1240, 1243,
1244, 1246, 1248,
1248
Art: 1280, 1285

Art. 1231
Kotwa
Art: 1240, 1243, 1244,
1246, 1248, 1248
Art: 1280, 1285

Art. 1907
Kotwa
Art: 1311, 1312
Art: 1901

Art. 1908
Kotwa
Art: 1311, 1312
Art: 1901

Akcesoria

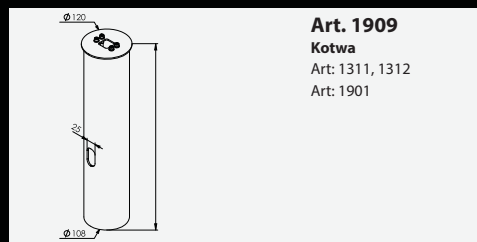

Art. 1909
Kotwa
Art: 1311, 1312
Art: 1901

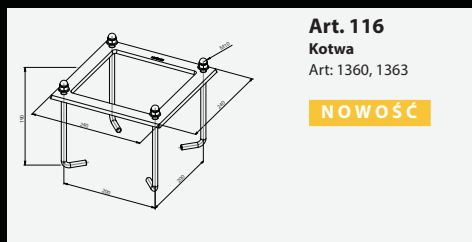

Art. 116
Kotwa
Art: 1360, 1363

NOWOŚĆ

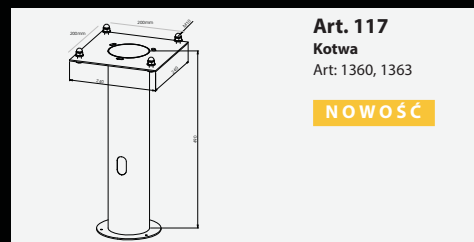

Art. 117
Kotwa
Art: 1360, 1363

NOWOŚĆ

Słup i akcesoria

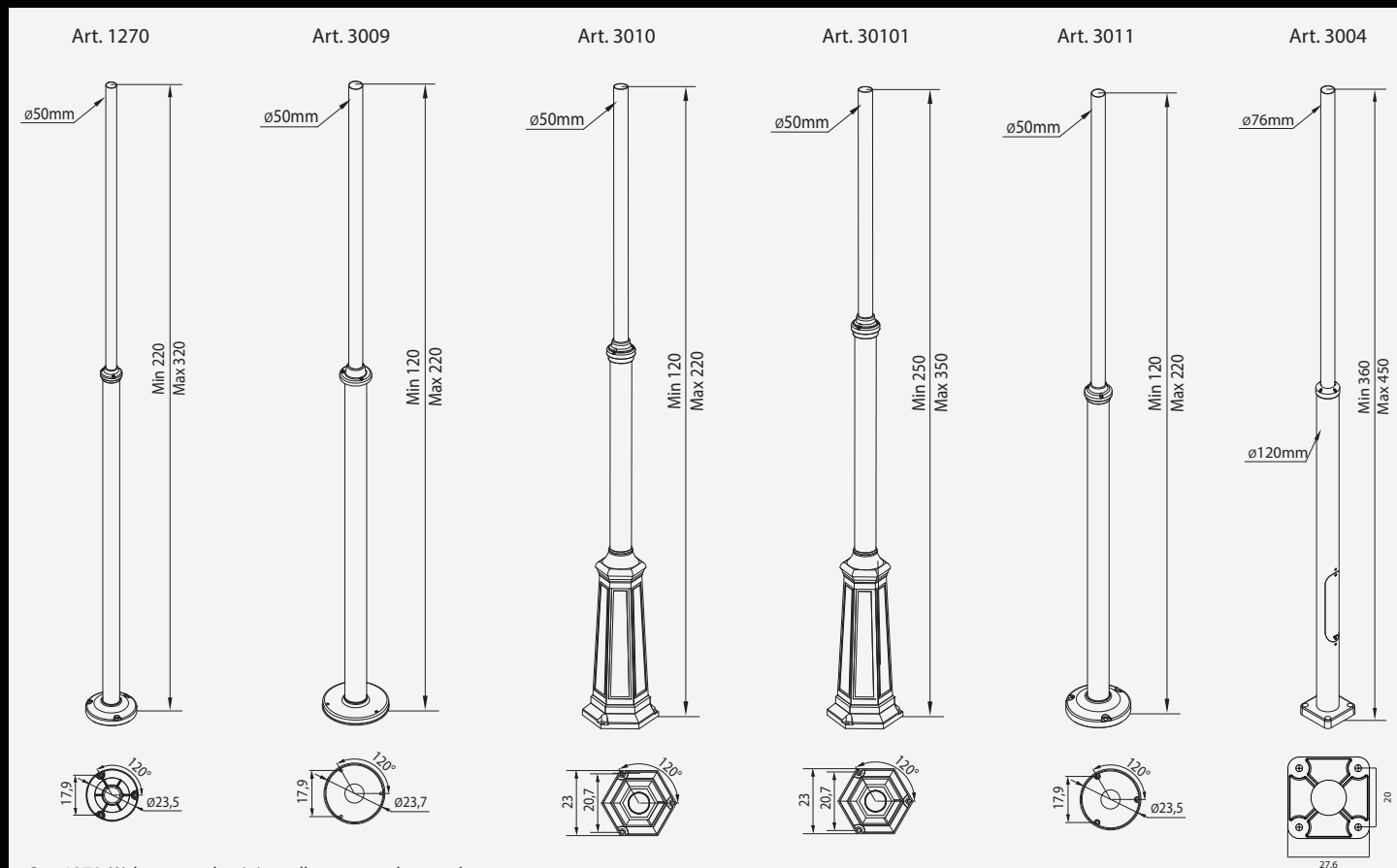

Art. 1270: Wykonany z aluminium, dla opraw malowanych

Art. 3009: Wykonany ze stali, dla opraw cynkowanych ogniowo

Art. 3010: Wykonany z aluminium, dla opraw klasycznych

Art. 30101: Wykonany z aluminium, dla opraw klasycznych

Art. 1270: Wykonany z aluminium, dla opraw malowanych

Art. 3004: Do opraw : VISBY, SUNNFJORD, NICEA i KOSTER, Do użytku publicznego, parków, parkingów.

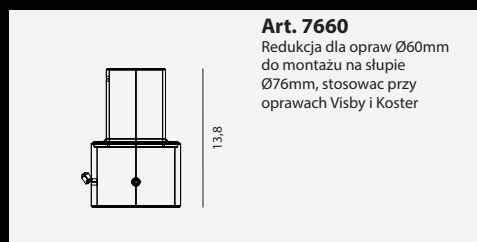

Art. 7660
Redukcja dla opraw Ø60mm do montażu na słupie Ø76mm, stosować przy oprawach Visby i Koster

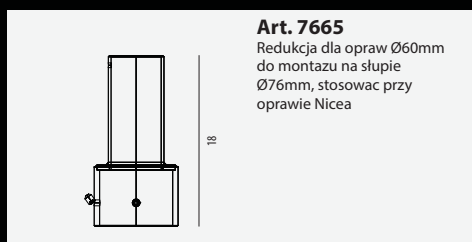

Art. 7665
Redukcja dla opraw Ø60mm do montażu na słupie Ø76mm, stosować przy oprawie Nicea

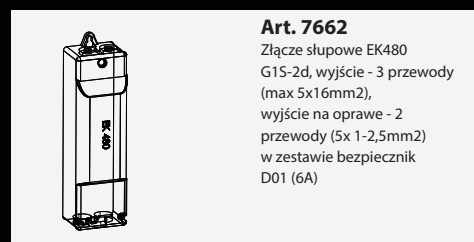

Art. 7662
Złącze słupowe EK480 G1S-2d, wyjście - 3 przewody (max 5x1.6mm²), wyjście na oprawie - 2 przewody (5x 1-2,5mm²) w zestawie bezpiecznik D01 (6A)



Art. 7661
Puszka przyłączeniowa z 5-cio torowa listwa przyłączeniowa

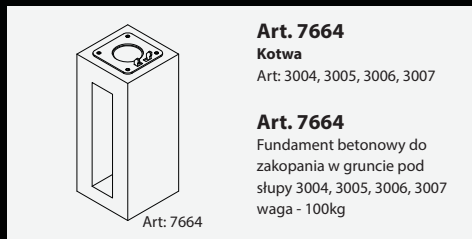

Art. 7664
Kotwa
Art: 3004, 3005, 3006, 3007

Art. 7664
Fundament betonowy do zakopania w gruncie pod słupy 3004, 3005, 3006, 3007 waga - 100kg



Art. 1509
Redukcja z osłoną dla oprawy Sunnfjord umożliwiającą montaż na słupie Ø60 mm



NORLYS

Since 1953

Dystrybutor:

Opłaty zawarte w katalogu dostępne u Dystrybutorów

Norlys Sp. z o.o.
ul. Zawiszy Czarnego 7
33-300 Nowy Sącz
tel. (18) 444-21-11
www.norlys.pl

Czerwiec 2018